

SYSTEM F1.40

Aluminium-Unterkonstruktion für
Vorgehängte hinterlüftete Fassaden

aluminum-substructure for
rainscreen cladding



	Einheiten	Seite
	units	page
Inhaltsverzeichnis / contents		00
<u>Massive Wand / massive wall</u>		
Übersicht / overview	metric	01
Konstruktionstiefe (Tabelle) / construction depth (table)	metric	02
Horizontalschnitt T-Profil / horizontal section T-profile	metric	03
Horizontalschnitt L-Profil / horizontal section L-profile	metric	04
Horizontalschnitt Aussenecke / horizontal section -external corner	metric	05
Horizontalschnitt Innenecke / horizontal section -internal corner	metric	06
Horizontalschnitt Fensterdetail / horizontal section- window detail	metric	07
Vertikalschnitt / vertical section	metric	08
Vertikalschnitt / vertical section	metric	09
Vertikalschnitt Profilverbindung / vertical section- joint of profile	metric	10
Vertikalschnitt Fensterdetail / vertical section-window detail	metric	11
Vertikalschnitt Fensterdetail / vertical section-window detail	metric	12
Vertikalschnitt Attikadetail / vertical section- parapet detail	metric	13

Hinweise: Die Ausführung der dargestellten Verbindungsmittel kann wahlweise als Blechschraube (\varnothing 4,8x19) oder Niete (\varnothing 5, Alu/NIRO oder NIRO/NIRO) erfolgen.

Fußnote 1): Die Breite des Hinterlüftungsspalt ist u.a. von den örtlichen Baubestimmungen bzw. den objektspezifischenbauphysikalischen Anforderungen abhängig.



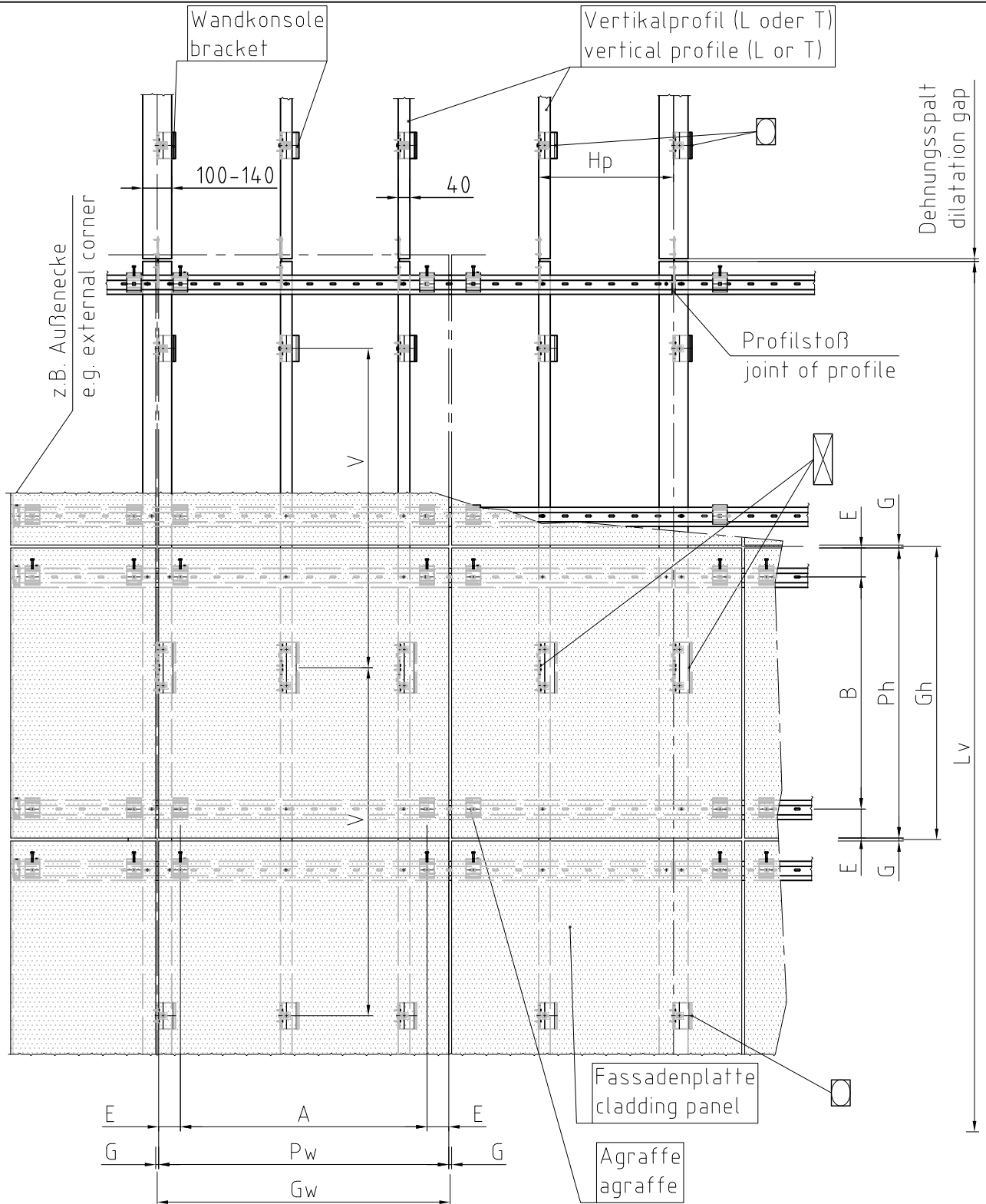

note: The realisation of the pictured fasteners can be carried out alternatively as tapping screw (\varnothing 4,8x19) or rivet (\varnothing 5 aluminium/stainless steel or stainl.steel/stainl.steel) .

footnote 1): The width of the ventilation area depends on local building specifications (standards) and object specific physical requirements.

Übersicht overview System F1.40



Legende / Legend

A....Plattenbefestigungsabstand panel fixing distance	Gw...Rasterbreite horizontal grid distance		Konsole F1 + als Festpunkt bracket F1 + used as fixed point
B....Plattenbefestigungsabstand panel fixing distance	Hp...horizontaler Profilabstand horizontal profile distance		Konsole F1 + als vertikaler Gleitpunkt bracket F1 + used as vertical flexible point
E....Randabstand der Befestigungsmittel edge distance of fixing elements	Lv...Profillänge (ca. 3m) length of profile (approx. 3m/120")		Konsole F1 als Festpunkt bracket F1 used as fixed point
G....Spaltbreite (zwischen den Platten) gap distance (between panels)	Ph...Plattenhöhe panel height		Konsole F1 als vertikaler Gleitpunkt bracket F1 used as vertical flexible point
Gh...Rasterhöhe vertical grid distance	Pw...Plattenbreite panel width		
	V....vertikaler Wandkonsolenabstand vertical bracket distance		

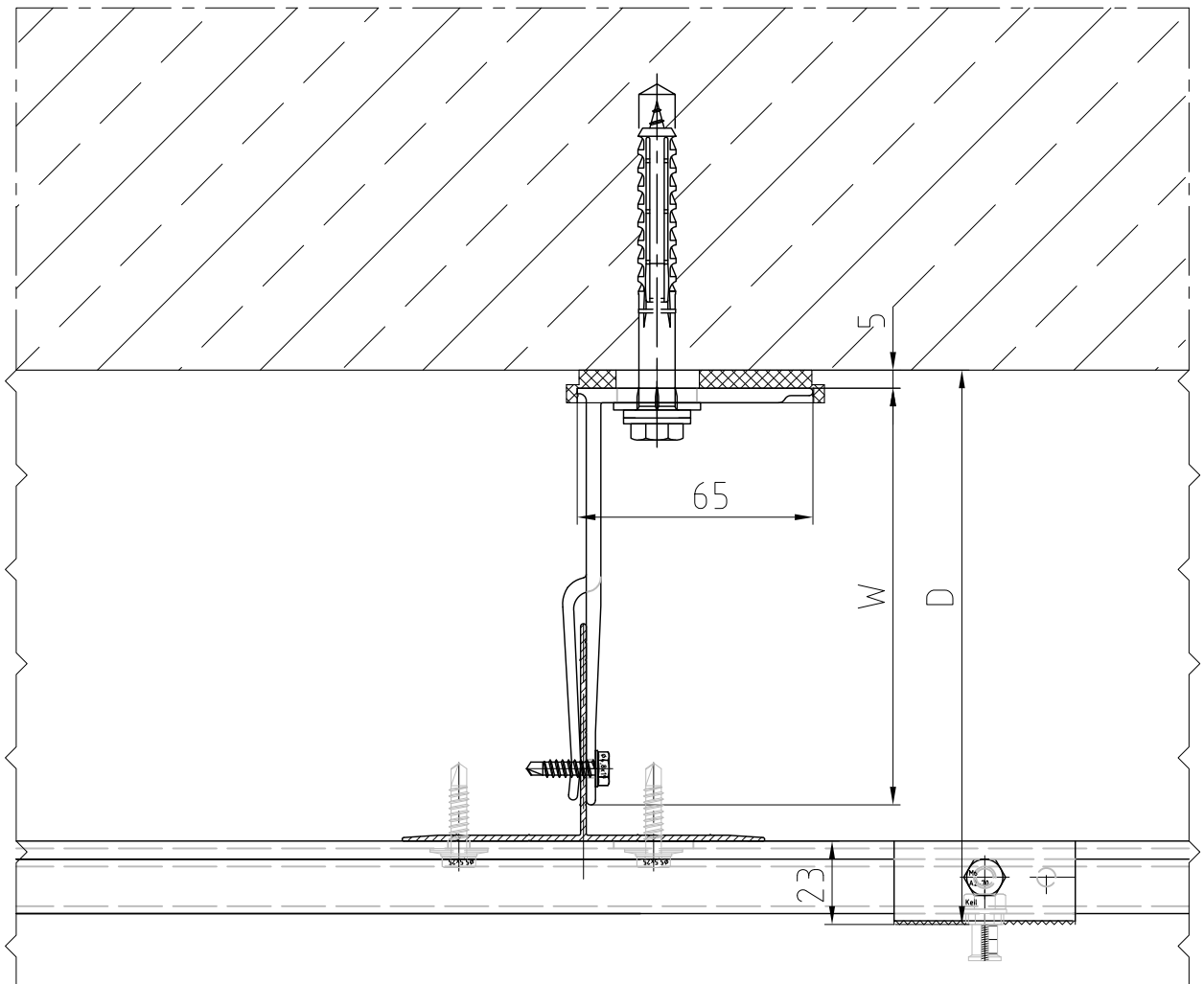

Maßstab/Scale 1:2

Masstabelle/ Table of Distances

Wandkonsole/bracket F1	Wandkonsole/ bracket F1+	Ausladung/ depth "W"	Entfernung/ distance "D"
F1.35	F1+35	35mm	74mm*)- 103mm
F1.50	F1+50	50mm	80mm*)- 118mm
F1.80	F1+80	80mm	110mm - 148mm
F1.100	F1+100	100mm	130mm - 168mm
F1.115	F1+115	115mm	145mm - 183mm
F1.135	F1+135	135mm	165mm - 203mm
F1.150	F1+150	150mm	180mm - 218mm
F1.170	F1+170	170mm	200mm - 238mm
F1.185	F1+185	185mm	215mm - 253mm
F1.200	F1+200	200mm	230mm - 268mm
F1.220	F1+220	220mm	250mm - 288mm
F1.255	F1+255	255mm	285mm - 323mm

*)Diese Maße können nur mit Vertikalprofilen mit geringerer Schenkellänge erreicht werden.
*)These distances can only be obtained by using vertical profiles with shorter flange length.

Horizontalschnitt
horizontal section
System F1.40

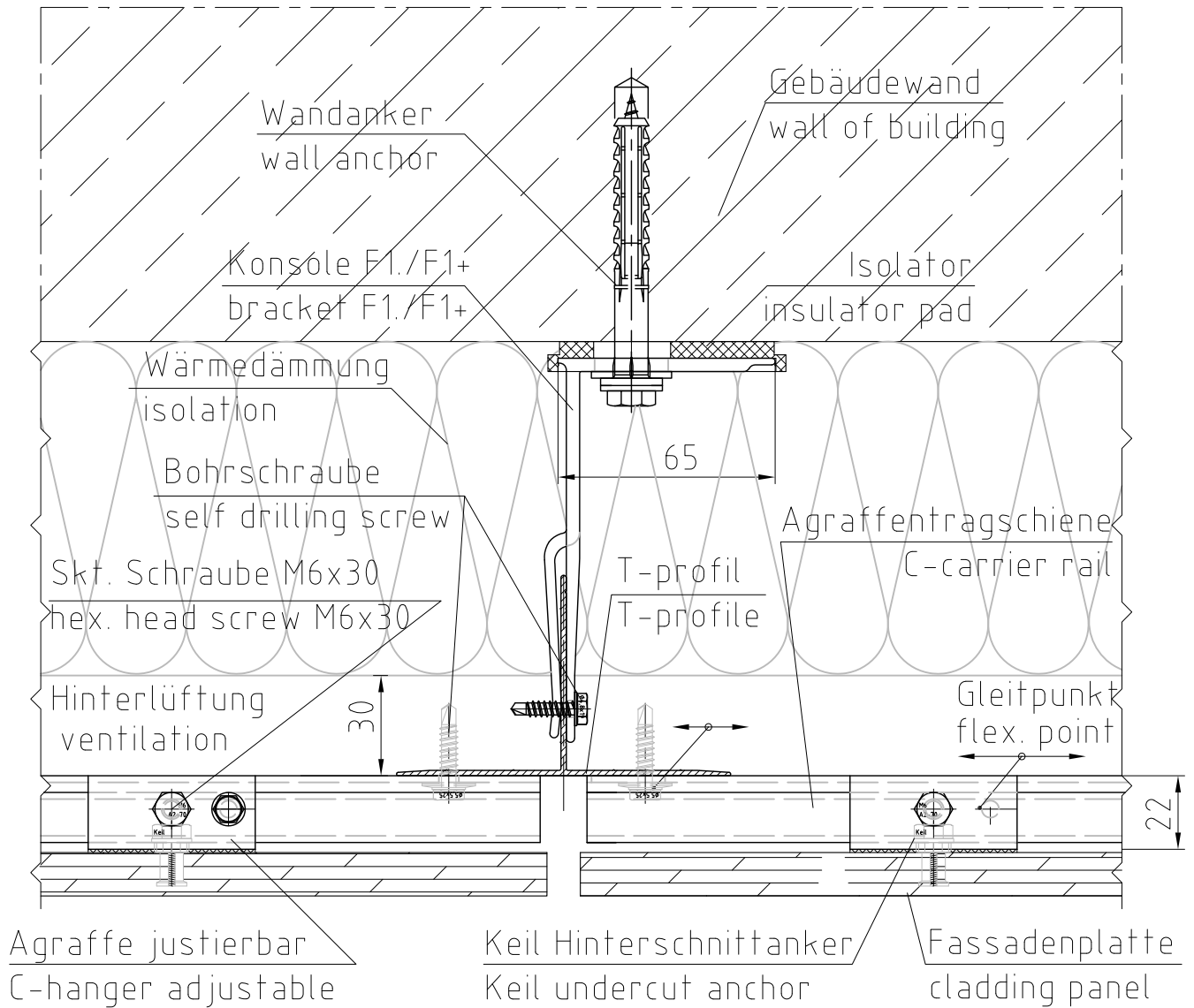

Maßstab/Scale 1:2

Horizontalschnitt
horizontal section
System F1.40

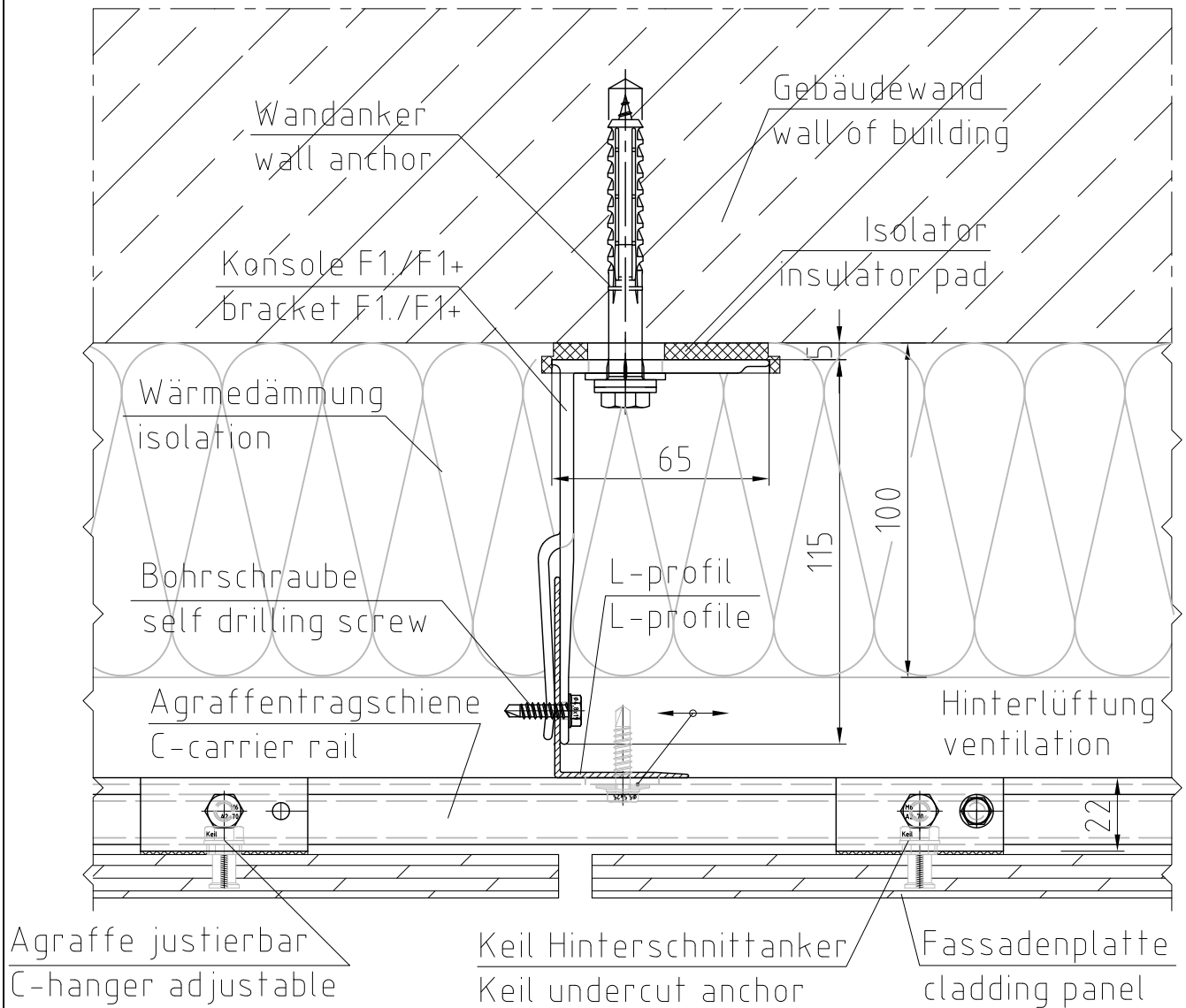

Maßstab/Scale 1:2

Horizontalschnitt Aussenecke
horizontal section external corner
System F1.40

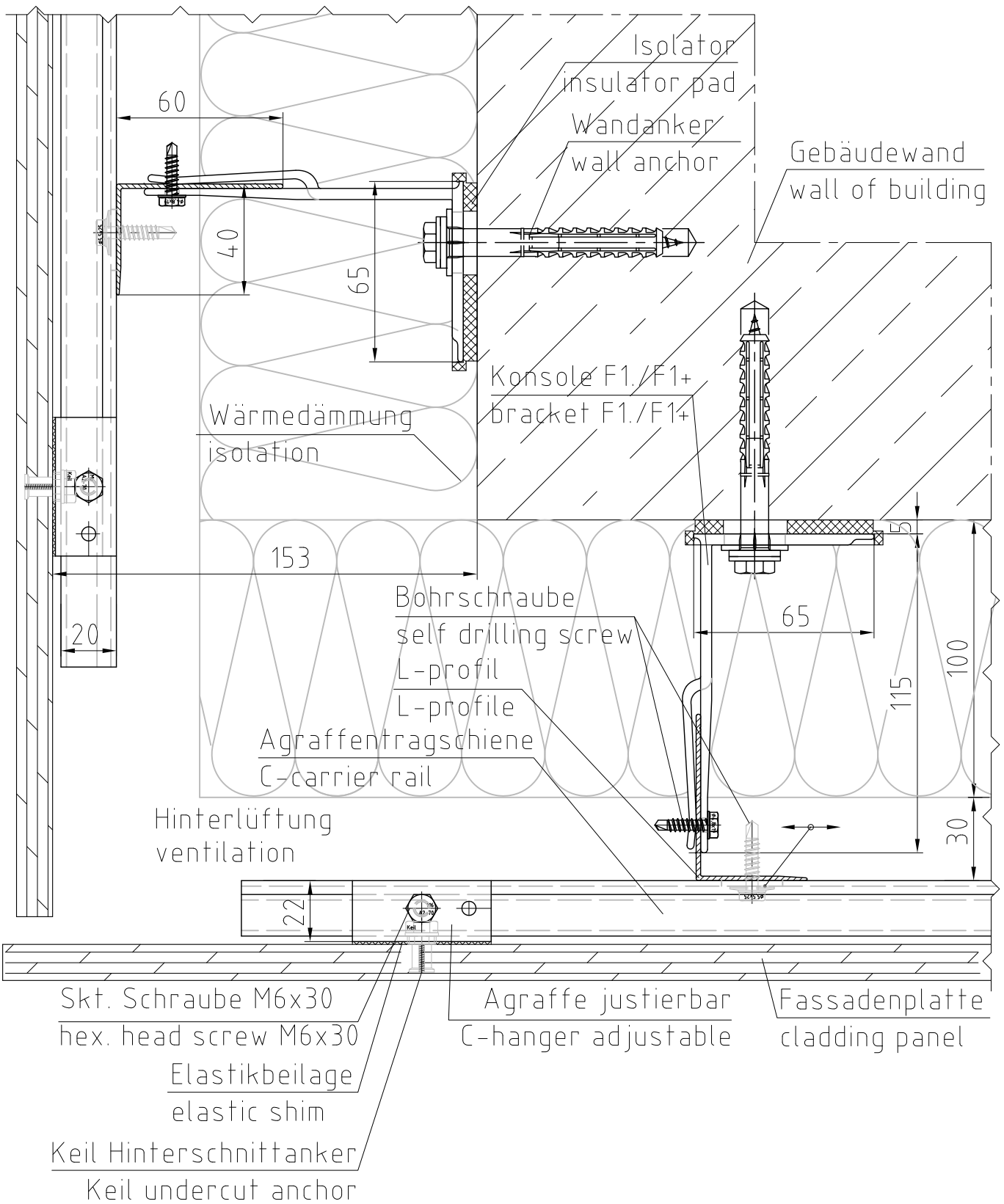

Maßstab/Scale 1:2

Horizontalschnitt Innenecke
horizontal section internal corner
System F1.40

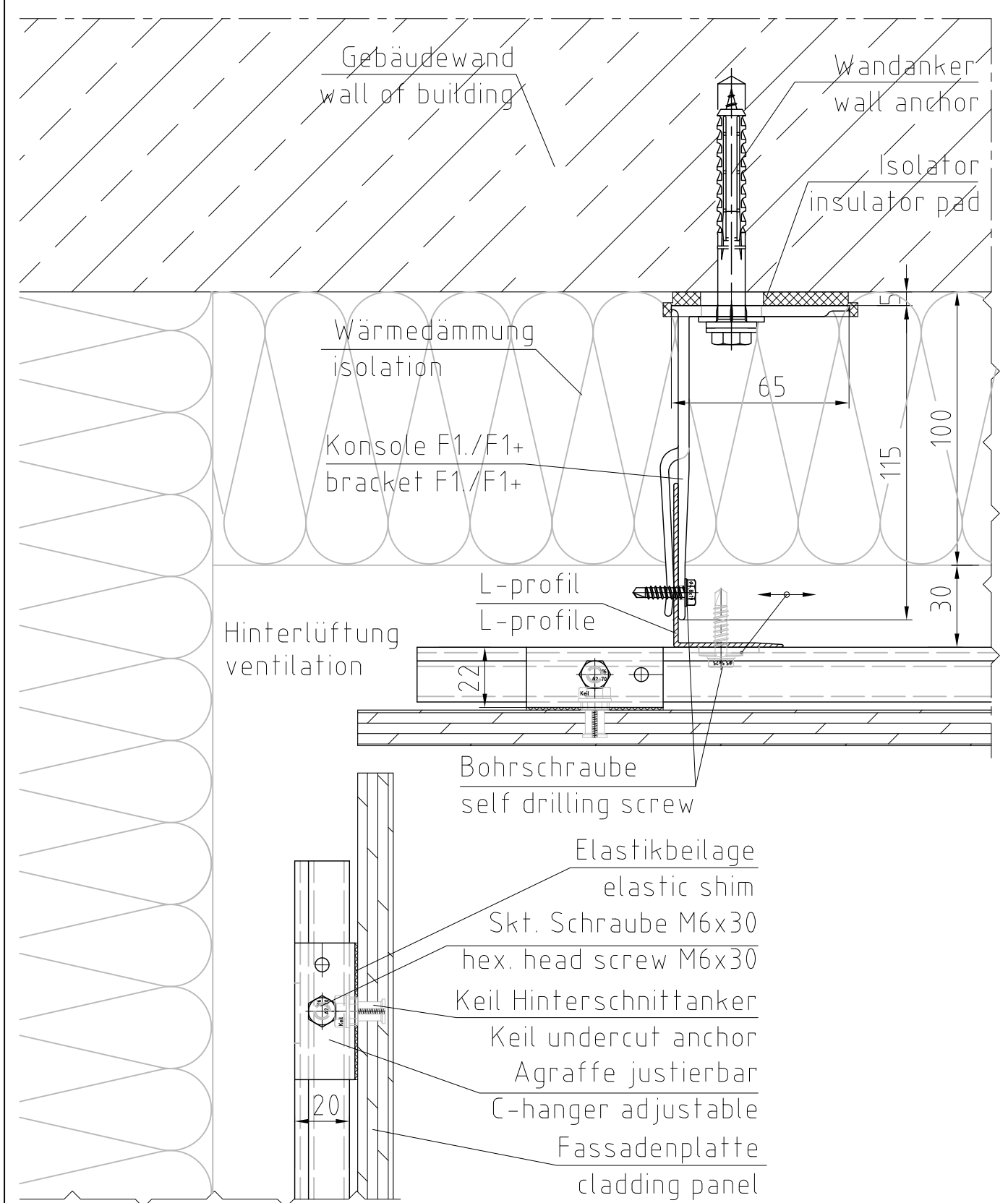

Maßstab/Scale 1:2

Horizontalschnitt Fensterdetail
horizontal section window detail
System F1.40

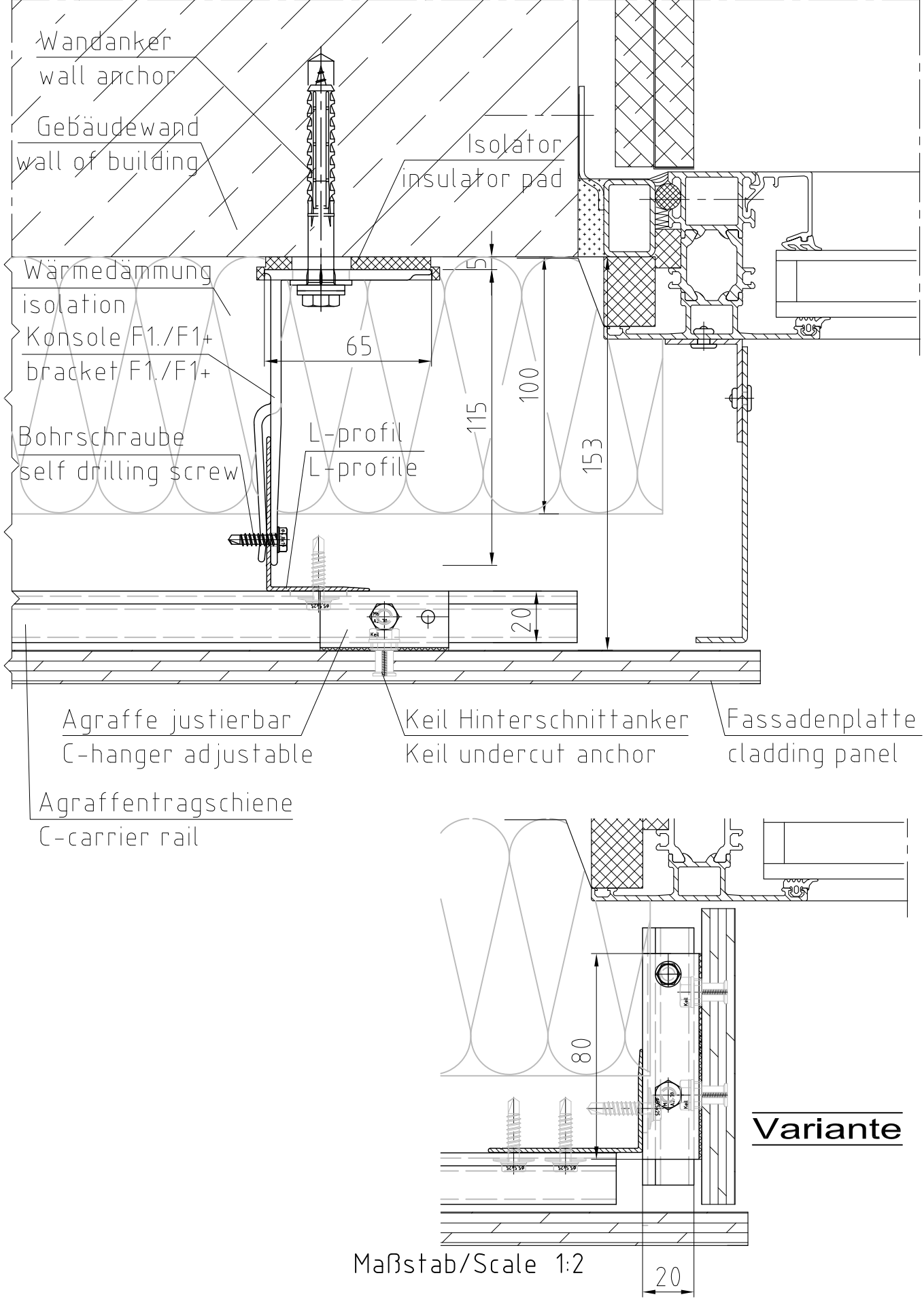

Maßstab/Scale 1:2

Vertikalschnitt
vertical section
System F1.40

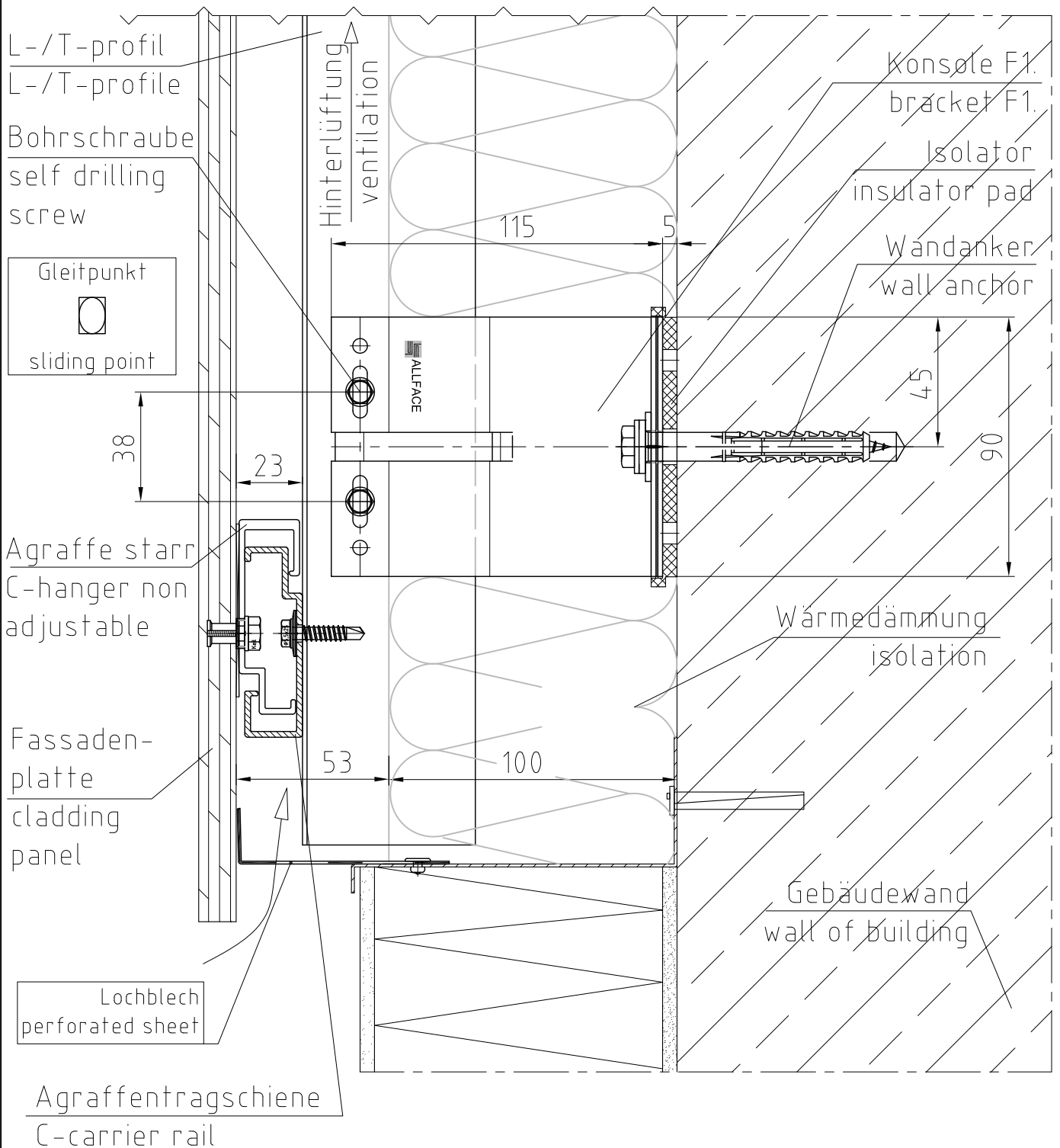

Maßstab/Scale 1:2

Vertikalschnitt
vertical section
System F1.40

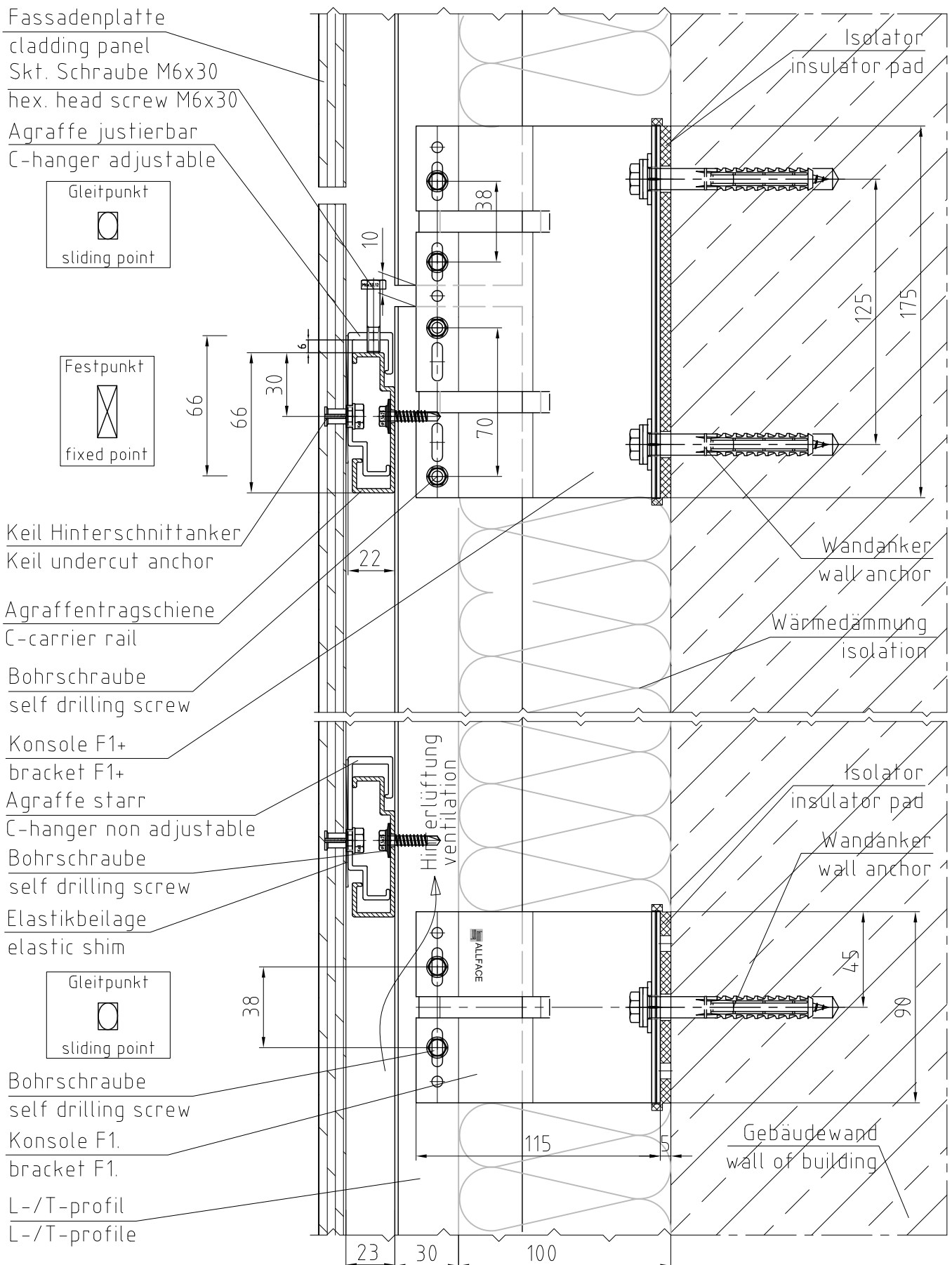

Maßstab/Scale 1:2,5

Vertikalschnitt Profilverbindung
vertical section joint of profile
System F1.40

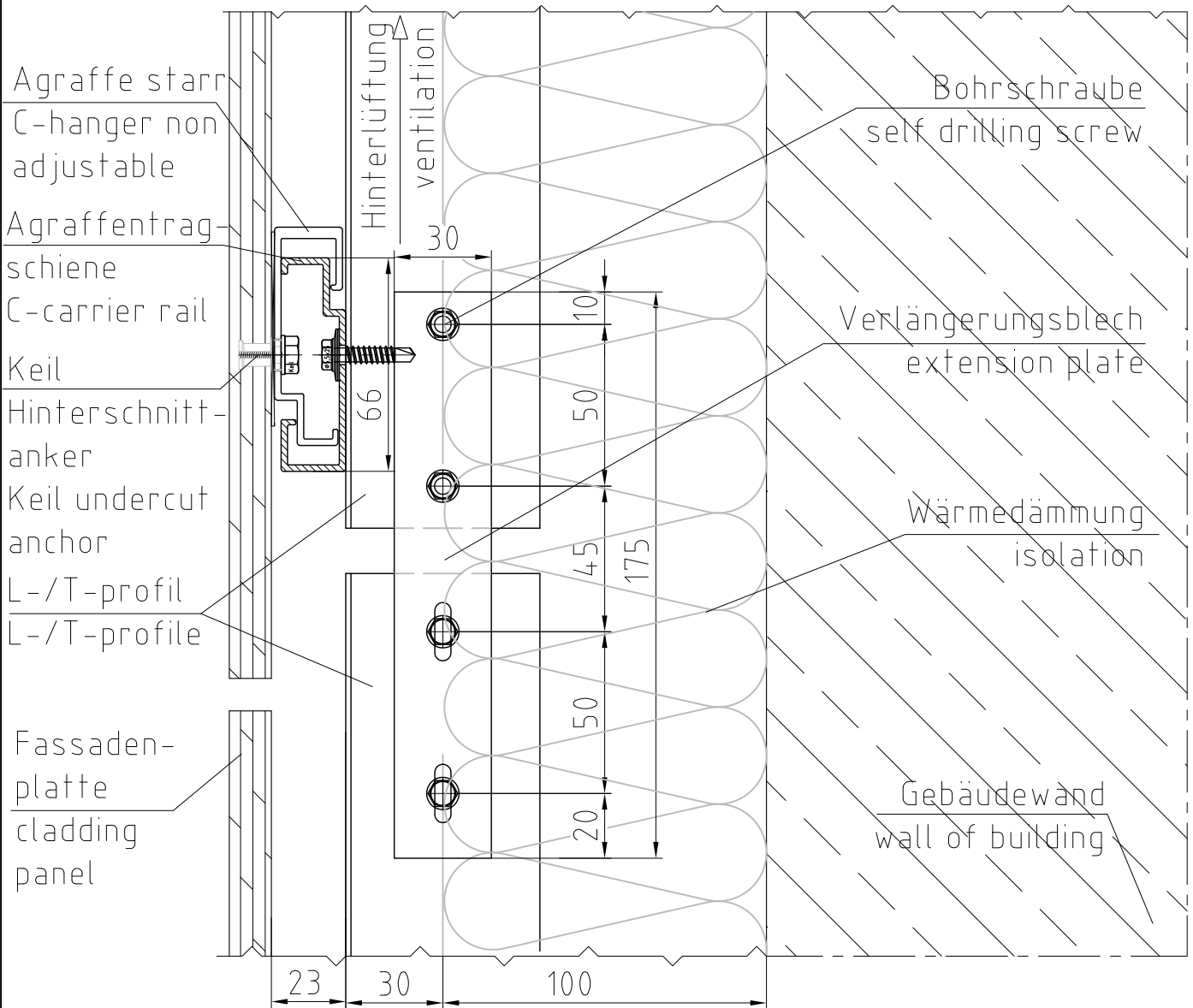

Maßstab/Scale 1:2

Vertikalschnitt Fensterdetail
vertical section window detail
System F1.40

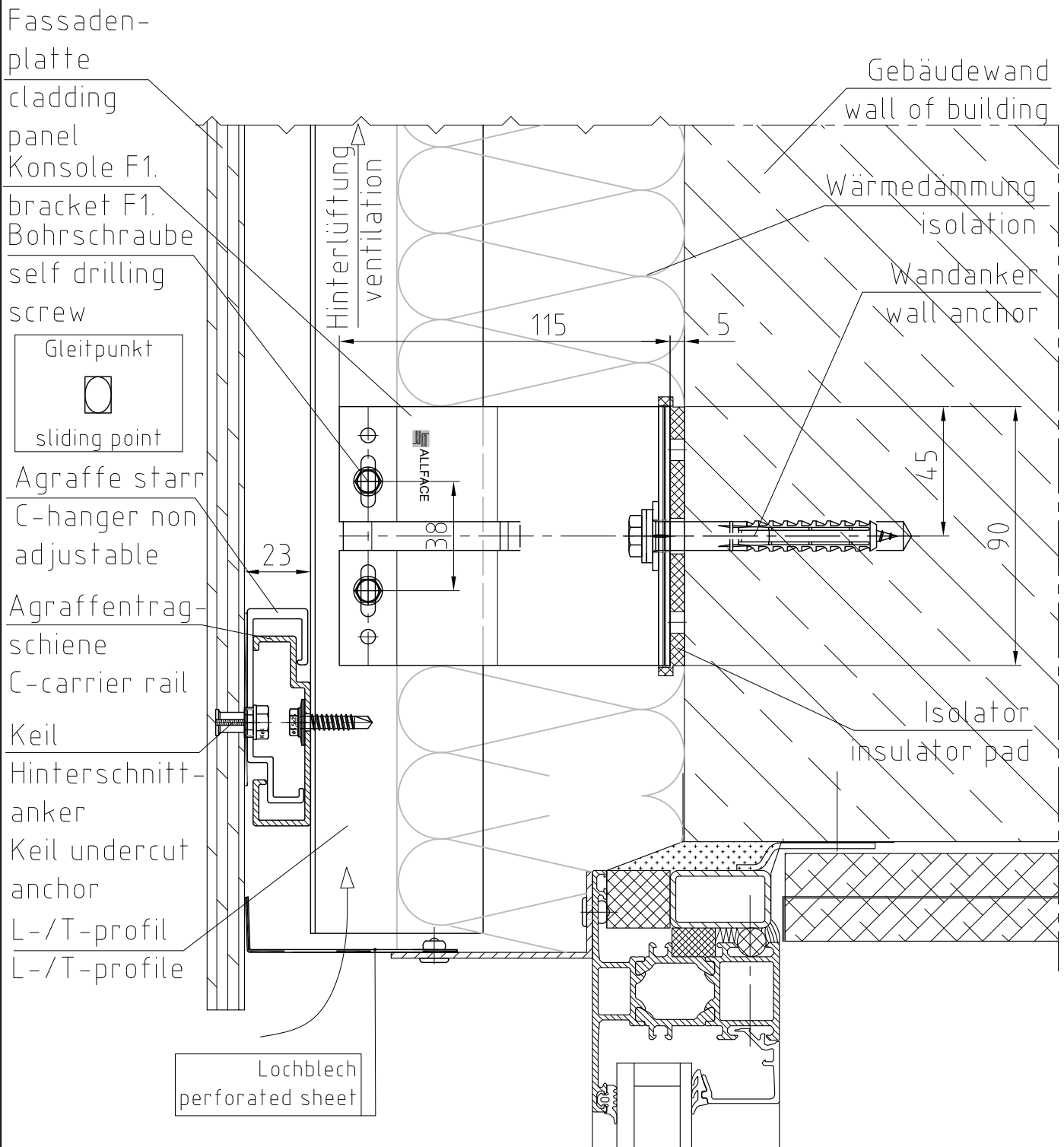

Vertikalschnitt Fensterdetail
vertical section window detail
System F1.40

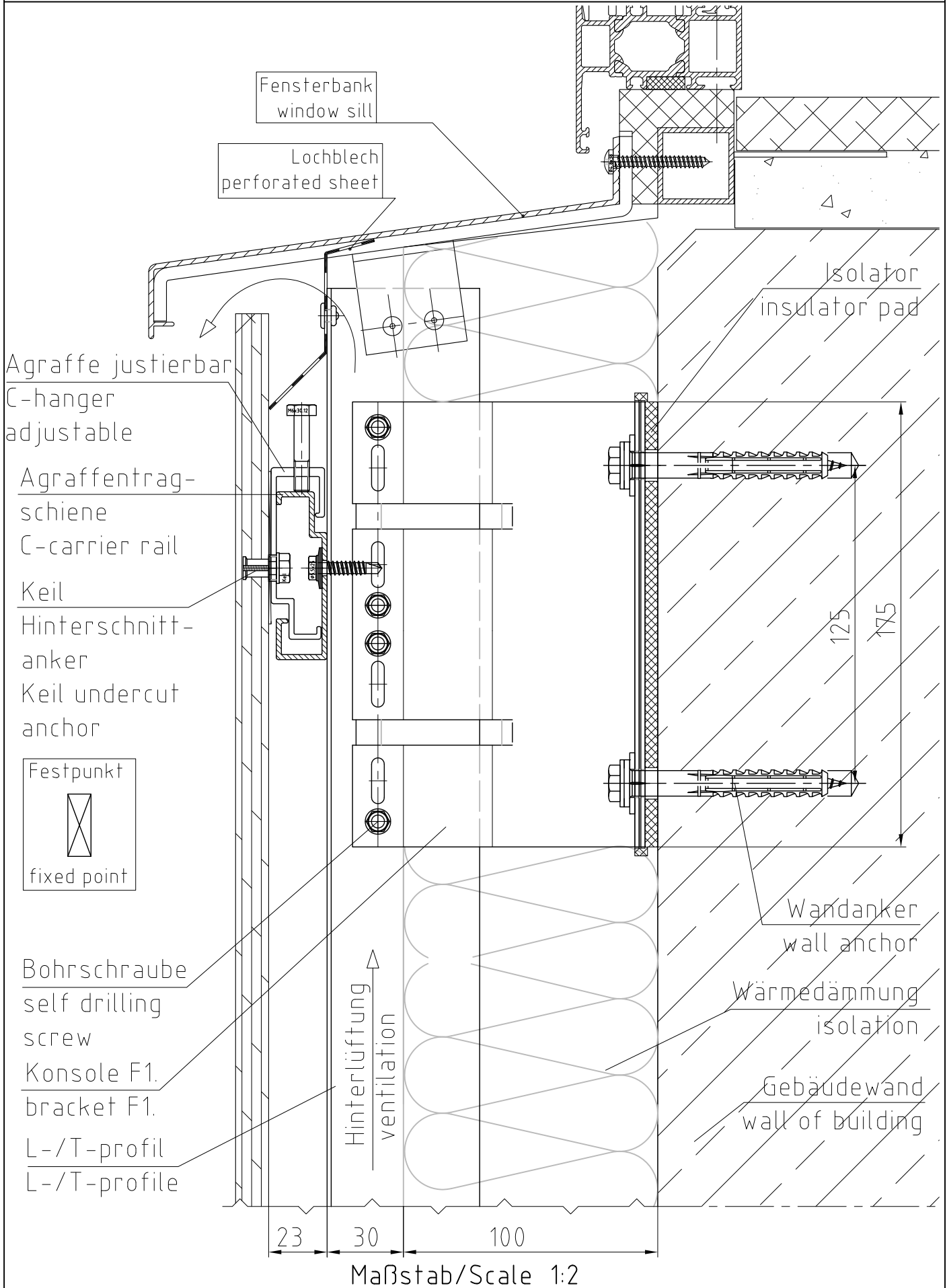

Vertikalschnitt Attikadetail
vertical section parapet detail
System F1.40

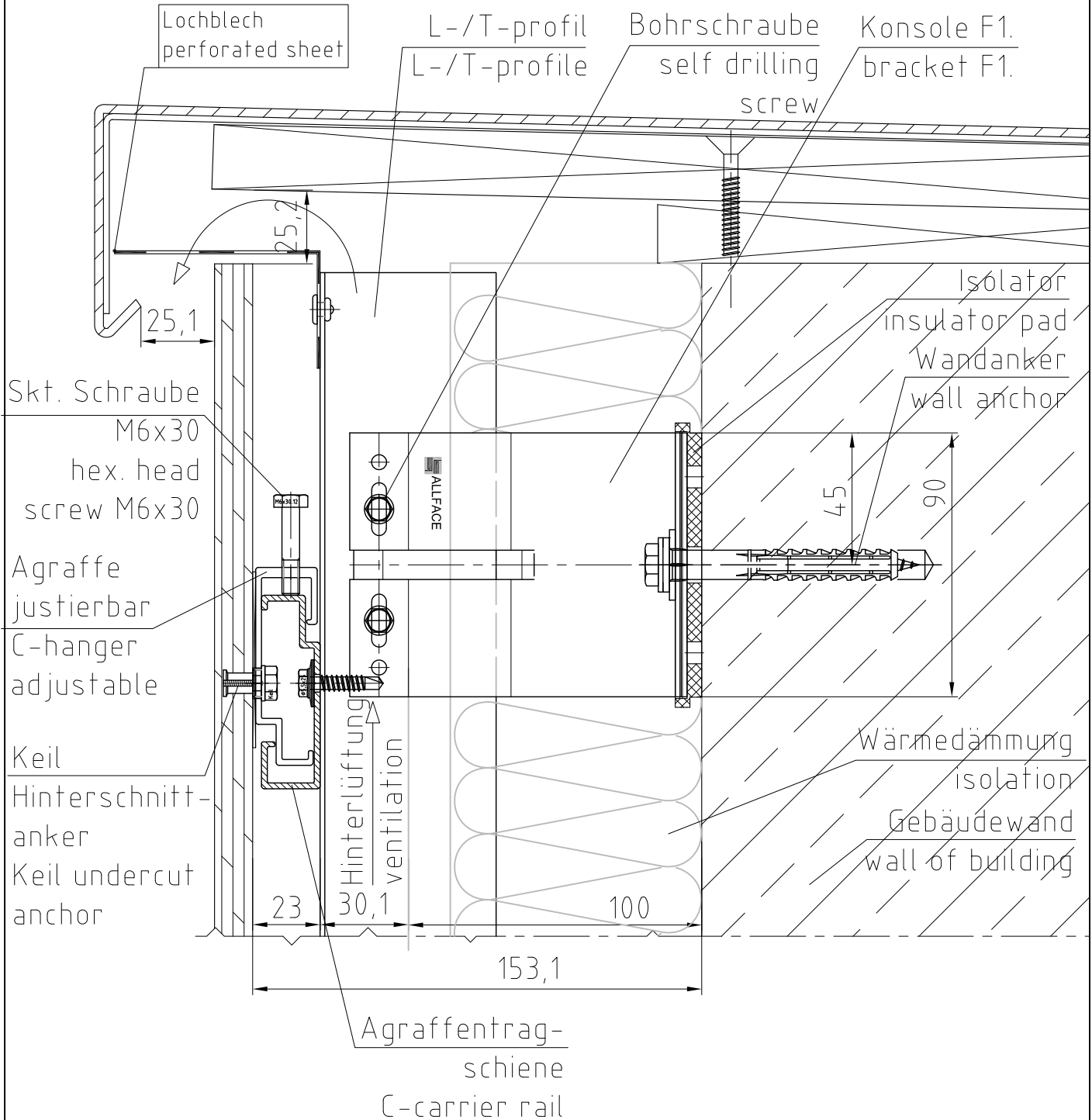

Maßstab/Scale 1:2