



Kiwa Ltd.
 Unit 5 Prime Park Way
 Prime Enterprise Park
 Derby
 DE1 3QB
 +44 (0)1332 383333
 uk.bpenquiries@kiwa.com
 www.kiwa.co.uk/bda

BAW-20-150-S-A-UK
BDA Agrément®
Safewall® with RockPanel A2
Rainscreen Cladding System

Benx Ltd.
 Lonsdale Chambers
 Lonsdale Street
 Stoke-on-Trent
 ST4 4BT
 T: +44 (0)845 130 0982
 E: technicalservices@benx.co.uk
 W: www.benx.co.uk

SCOPE OF AGRÉMENT

This BDA Agrément® (hereinafter 'Agrément') relates to Safewall® with RockPanel A2 Rainscreen Cladding System (hereinafter the 'System'). The System is a mechanically fixed, non-loadbearing, drained and ventilated rainscreen cladding system, suitable for installation above the damp-proof course (hereinafter 'DPC') level on light gauge steel frame (hereinafter 'LGSF') supporting walls. The System is for use on external walls of new and existing residential and commercial buildings.

DESCRIPTION

The System consists of cladding panels mechanically fastened to the AllFace Smart Fixing System (hereinafter 'subframe', comprising vertical rails, brackets, isolator pads and subframe fasteners), insulation board, breather membrane and sheathing board. The cladding panels are mechanically fixed with aluminium rivets to the vertical rails (L/T-profiles), which are fixed with stainless steel screws to the aluminium brackets of the subframe. Mineral wool (hereinafter 'MW') or phenolic foam (hereinafter 'PF') insulation boards are fixed to the sheathing boards with carbon steel fixings through plastic washers, fitted within the aluminium subframe. The vertical rails of the subframe are mechanically fixed to the sheathed supporting wall with stainless steel screws through the aluminium brackets and isolator pads.

ILLUSTRATION

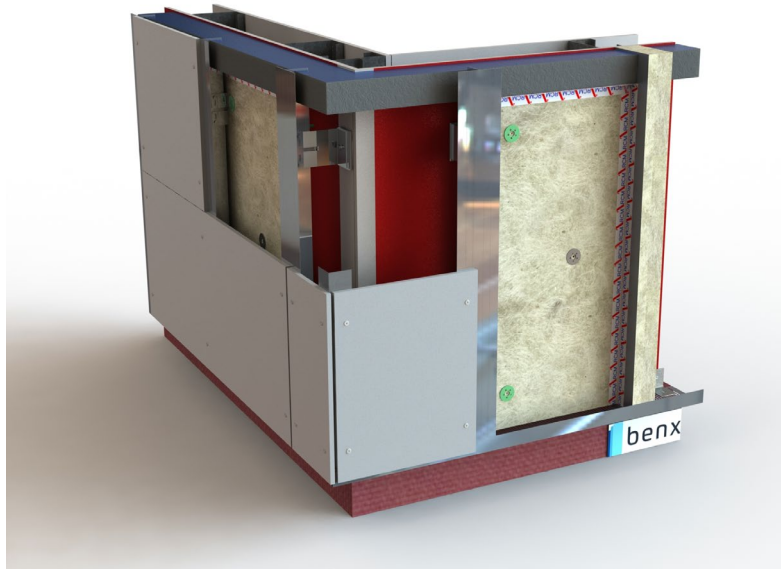

THIRD-PARTY ACCEPTANCE

None requested by the Agrément holder.

STATEMENT

It is the opinion of Kiwa Ltd. that the System is safe and fit for its intended use, provided it is specified, installed and used in accordance with this Agrément.

Craig Devine
 Operations Manager, Building Products

Alpheo Mlotha CEng FIMMM MBA
 Business Unit Manager, Building Products

SUMMARY OF AGRÉMENT

This document provides independent information to specifiers, specialists, engineers, building control personnel, contractors, installers and other construction industry professionals who are considering the safety and fitness for purpose of the System. This Agrément covers the following:

- Conditions of use;
- Production Control, Quality Management System and the Annual Verification Procedure;
- System components and ancillary items, points of attention for the Specifier and examples of details;
- Installation;
- Independently assessed System characteristics and other information;
- Compliance with national Building Regulations, other regulatory requirements and Third-Party Acceptance, as appropriate;
- Sources.

MAJOR POINTS OF ASSESSMENT

Moisture control - see Section 2.2.7 – the System:

- can contribute to limiting the risk of interstitial and surface condensation;
- can resist wind-driven rain penetration across the drained and ventilated cavity to the supporting wall.

Strength - see Section 2.2.8 - the System has adequate strength to resist wind loads normally encountered in the UK.

Fire performance - see Section 2.2.9 – the System is classified as European Classification A2-s1, d0, in accordance with BS EN 13501-1, when incorporating MW insulation and A1 sheathing boards. The reaction to fire classification of each System component is detailed in Section 2.2.9.

Thermal performance - see Section 2.2.10 - the System improves the thermal performance of external walls and can contribute to satisfying the requirements of the national Building Regulations.

Durability - see Section 2.2.11 - the service life durability of the System will be dependent upon the environment (operating conditions) in which the System will be used.

UKCA, UKNI and CE marking - see Section 2.2.12 - the manufacturers of the constituent products used within the System have responsibility for conformity marking, in accordance with all relevant British and European Product Standards.

CONTENTS

Section 1 - General considerations

- 1.1 - Conditions of use
- 1.2 - Production Control and Quality Management System
- 1.3 - Annual Verification Procedure - continuous surveillance

Section 2 - Technical assessment

- 2.1 - System components and ancillary items
- 2.2 - Points of attention to the Specifier
- 2.3 - Examples of typical details
- 2.4 - Installation
- 2.5 - Independently assessed System characteristics

Section 3 - CDM, national Building Regulations and Third-Party Acceptance

- 3.1 - The Construction (Design and Management) Regulations 2015 and The Construction (Design and Management) Regulations (Northern Ireland) 2016
- 3.2 - The national Building Regulations
- 3.3 - Third-Party Acceptance

Section 4 - Sources

Section 5 - Amendment history

Section 6 - Conditions of use

1 GENERAL CONSIDERATIONS

1.1 CONDITIONS OF USE

1.1.1 Limitations

This Agrément has been prepared in accordance with the mandatory requirements defined in the relevant Kiwa Technical Requirement. Some information in this Agrément is provided for guidance or reference purposes only; this information falls outside the scope of the Technical Requirement.

1.1.2 Application

The assessment of the System relates to its use in accordance with this Agrément and the Agrément holder's requirements.

1.1.3 Assessment

Kiwa Ltd. has assessed the System in combination with relevant test reports, technical literature, the Agrément holder's quality plan, DoPs and site visit, as appropriate.

1.1.4 Installation supervision

The quality of installation and workmanship shall be controlled by a competent person who shall be an employee of an Approved Installer.

The System shall be installed strictly in accordance with the instructions of the Agrément holder and the requirements of this Agrément.

1.1.5 Geographical scope

The validity of this document is limited to England, Wales, Scotland, Northern Ireland and Ireland, with due regard to Section 3 of this Agrément (CDM, national Building Regulations and Third-Party Acceptance).

1.1.6 Validity

The purpose of this Agrément is to provide well-founded confidence to apply the System within the scope described. The validity of this Agrément is as published on www.kiwa.co.uk/bda.

1.2 PRODUCTION CONTROL AND QUALITY MANAGEMENT SYSTEM

Kiwa Ltd. has conducted an audit of the Agrément holder and determined that they fulfil all their obligations in relation to this Agrément in respect of the System.

The initial audit demonstrated that the Agrément holder has a satisfactory Quality Management System (QMS) and is committed to continuously improving their quality plan. Document control and record-keeping procedures were deemed satisfactory. A detailed Production Quality Specification (PQS) has been compiled to ensure traceability and compliance under the terms of this Agrément.

1.3 ANNUAL VERIFICATION PROCEDURE - CONTINUOUS SURVEILLANCE

To demonstrate that the System conforms with the requirements of the technical specification described in this Agrément, an Annual Verification Procedure has been agreed with the Agrément holder in respect of continuous surveillance and assessment, and auditing of the Agrément holder's QMS.

2 TECHNICAL ASSESSMENT

This Agrément does not constitute a design guide for the System. It is intended only as an assessment of safety and fitness for purpose.

2.1 SYSTEM COMPONENTS AND ANCILLARY ITEMS

2.1.1 Components included within the scope of this Agrément

The components listed in Table 1 below are integral to the use of the System.

Table 1 - Integral components

Component	Description	Dimensions		
sheathing board	RCM Y-wall	exterior grade calcium silicate fibre cement particle board, with mechanical strength Class 2 and weather resistance Category A, density 1,200 kg/m ³ , manufactured in accordance with BS EN 12467	1.2 m wide by 2.4 m long by 9, 12 and 15 mm thick	
	RCM Multipurpose	exterior grade fibre cement particle board, with mechanical strength Class 2 and weather resistance Category A, density of 1,380 kg/m ³ , manufactured in accordance with BS EN 12467	1.2 m wide by 2.4 m long by 9 and 12 mm thick	
	RCM Cemboard	external cement bonded particle board, with bending strength ≥ 9 N/mm ² , release of formaldehyde Class E1, density of 1,250 kg/m ³ , manufactured in accordance with BS EN 13986	1.2 m wide by 2.4 m long by 10 and 12 mm thick	
	illbruck ME315 tape	single-sided black tape with solvent free modified acrylic dispersion adhesive to seal joints of sheathing boards	60 mm, 100 mm and 150 mm wide by 25 m long	
breather membrane	illbruck ME010	black polyester-based breather membrane, manufactured in accordance with BS EN 13859-2	1.5 m wide by 50 m long roll by 0.4 mm thick	
	Proctor Wraptite	polypropylene-based breather membrane, manufactured in accordance with BS EN 13859-2	1.5 m wide by 50 m long roll by 0.65 mm thick	
	Thermic Technology PhotonWrap	reflective breather membrane, manufactured in accordance with BS EN 13859-2	1.35 m wide by 50 m long roll by 0.15 mm thick	
insulation board	Knauf Rocksilk Rainscreen slab	rock MW insulation, λ_D 0.034 W/mK and density 55 kg/m ³ , manufactured in accordance with BS EN 13162	0.6 m wide by 1.2 m long by 65 to 160 mm thick	
	Rockwool Rainscreen Duo slab	rock MW insulation, λ_D 0.034 W/mK and density 60 kg/m ³ , manufactured in accordance with BS EN 13162	0.6 m wide by 1.2 m long by 50 to 225 mm thick	
	Kingspan Kooltherm K15	rigid PF insulation with foil composite facing, λ_D 0.021 W/mK (25 to 44 mm thick) or 0.020 W/mK (45 to 150 mm thick) and density 40 kg/m ³ , manufactured in accordance with BS EN 13166	0.6 or 1.2 m wide by 1.2 or 2.4 m long by 25 to 150 mm thick	
mechanical fixings for insulation	Rawplug R-WX-T screw and Rawplug KC washer	SAE C1022 self-drilling carbon steel screw with hardened thread surface, and polycaprolactam washer	4.8 mm diameter by 50 to 300 mm long screw, with 60, 70 or 90 mm diameter washer	
	Evolution IS screws and Evolution ECW washer			
fire-resistant fixings for insulation	Evolution A4IS screw and Rawplug MKC-SS or Evolution SSSPR70 washer	SAE C1022 carbon steel - drilling point AISI 316/EN 1.4401 (A4) stainless steel, and 1.4401 (A4) stainless steel washer for insulation	4.8 mm screw diameter by 45 to 300 mm long, with 70 mm diameter washer	
subframe	Allface Smart Fixing System F1.10 (face fix with rivets)	F1 untreated EN AW-6060 T66 grade aluminium alloy bracket with three slots, manufactured in accordance with BS EN 573-3	35 to 320 mm long by 4 mm thick, ends of bracket incorporating 5.1 mm diameter holes and 18 mm slots to create fixed or sliding point connections with rails	
		F1+ untreated EN AW-6060 T66 grade aluminium alloy bracket with five slots, manufactured in accordance with BS EN 573-3		
		T-profile vertical rail, untreated EN AW-6063 T66 grade aluminium alloy, manufactured in accordance with BS EN 573-3		70 mm to 120 mm wide by 60 mm high by 2 mm thick
		L-profile vertical rails, untreated EN AW-6063 T66 grade aluminium alloy, manufactured in accordance with BS EN 573-3		40 mm wide by 60 mm high by 2 mm thick
	Allface isolator pad F1/F1+	polyethylene (PE) isolator pad, density 960 kg/m ³	71.2 mm wide by 97 mm high by 5 mm thick	
	RCM Y-Wall isolator pad	calcium silicate fibre-cement particle board isolator pad, manufactured in accordance with BS EN 12467, density 1,200 kg/m ³	Up to 15 mm thick	
mechanical fixings for subframe	Ejot screw JT4-4-4.8	subframe fastener, grade A2 stainless steel self-drilling screw with EPDM washer to connect vertical rails (L/T-profiles) and brackets	4.8 mm screw diameter by 19 mm long	
cladding panel	RockPanel A2	panel consisting of a four-layer water-borne polymer emulsion paint with ProtectPlus anti-graffiti clear coat as a fifth layer on the external face, manufactured in accordance with EAD 090001-00-0404	1.25 m wide by 3.050 m long by 9 mm thick	
mechanical fixings for cladding panel	SFS rivet AP14	aluminium EN AW-5019 rivet body and stainless steel A2 (1.4541, AISI 321) mandrel	5.0 mm diameter by 18 mm long, with 14 mm flange and 9.5 to 13.5 mm grip range	
	Rockpanel fixed point sleeve FP-A-7.9x6	aluminium rivet sleeve to support the self-weight of a panel; minimum one per panel	7.9 mm diameter aluminium ring to suit 6 mm diameter hole	
	Rockpanel Sliding point sleeve GP-A 1638759		8.5 mm diameter aluminium ring to suit 5.1x6.7 mm slot	

2.1.2 Ancillary items falling outside the scope of this Agrément

The following ancillary items detailed in this Section may be used in conjunction with the System, but fall outside the scope of this Agrément:

- plasterboard - inner liner;
- cavity barrier and intumescent strip;
- vapour control layer (hereinafter 'VCL');
- EPDM membrane and adhesive - for sealing wall/window interface;
- breathable, water-resistant tape - tape to be used with insulations on joints and edges;
- DPC;
- cavity tray;
- profiles - angle profiles, perforated angle profile, U or F-profile;
- mechanical fixings - Rawplug screw R-CWTS-48038-LG Csk and Ejot screw JT3-3-6.3;
- sealants.

2.2 POINTS OF ATTENTION TO THE SPECIFIER

2.2.1 Design

2.2.1.1 Design responsibility

Project-specific design is the responsibility of a Specifier, who shall co-operate with the Agrément holder.

2.2.1.2 Basis of design

The characteristics detailed in the section titled 'Major Points of Assessment' shall be considered during the use of the System.

2.2.1.3 General design considerations

A project-specific design is required. This shall be done in close co-operation with the Agrément holder.

This Agrément covers the use of the System in any exposure zone, subject to the following conditions (particularly important in areas subject to severe or very severe driving rain):

- compliance with the relevant national Building Regulations;
- compliance with weathertightness and the relevant site exposure zone in accordance with BRE Report 262, using the local wind-driven rain index in accordance with BS 8104.

Assessment of the structural performance of the System shall be carried out by a suitably qualified structural engineer to confirm that the System can:

- resist the design impact, wind, dead and imposed loads;
- safely transfer loads to the supporting wall;
- accommodate all anticipated thermal movements without damage.

Deflection shall be limited to prevent damage to the System.

The System shall be installed above DPC level and a minimum of 150 mm above ground level.

LGSF supporting walls shall be designed in accordance with BS EN 1993-1-1 / I.S. EN 1993-1-1 and BS EN 1993-1-3 / I.S. EN 1993-1-3; the steel structures shall not be less than 1.2 mm thick with a minimum of 50 mm flanges.

Sheathing boards shall be classified as European Classification A1 or A2-s1, d0, in accordance with BS EN 13501-1, when the building height is over:

- 11 m for residential and 18 m for non-residential buildings in England, Wales and Northern Ireland;
- 11 m in Scotland for all buildings;
- 15 m for residential and 18 m for non-residential buildings in Ireland.

Supporting walls shall be designed in accordance with the relevant Standards to limit mid-span deflections - see Section 2.2.8.

Supporting walls incorporating the System shall be detailed to reduce the risk of damage due to movement in the LGSF supporting wall, taking into consideration differential movement in dissimilar materials.

Buildings incorporating the System shall be designed and constructed to prevent moisture penetration and air infiltration, in accordance with the relevant Codes and Standards.

Cavity barriers shall be installed to control the spread of smoke and fire. Cavity barriers may also be used for pressure equalisation, to improve System resistance to rain penetration.

The drained and ventilated cavity behind the insulation shall not be allowed to become blocked. Openings shall be kept clean and free of obstructions. Appropriate netting at ventilation openings shall be arranged to prevent the ingress of rain, snow, birds and small animals, and the risk of blockage by other building operations.

Allowances shall be made for minimum 10 mm wide open joints between cladding panels and a 50 mm air gap directly behind the cladding panels.

Where required, properly constructed movement joints (designed to cater for the calculated degree of movement to control expansion and contraction without reducing the stability and weathertightness of the wall) shall be carried through the System using movement beads of PVC, powder-coated galvanised steel or stainless steel. Movement joints within the System shall be:

- reflected through sheathing board joints;
- located on no more than two floor levels (horizontally) and 12 linear metres (vertically);
- in accordance with the project-specific design;
- via the subframe, and horizontal movement joints shall be incorporated in accordance with Allface design recommendations.

2.2.1.4 Project-specific design considerations

The project-specific design shall:

- be determined by the Specifier;
- take into account the requirements of the relevant national Building Regulations - see Section 3.2;
- take into account the service life durability required - see Section 2.2.11.

A pre-installation survey is required to allow determination of the project-specific design - see Section 2.4.1.

The Specifier shall ensure that the following considerations are included in the development of a project-specific design:

- structural adequacy of the supporting wall;
- thermal transmittance (hereinafter 'U-value') requirements;
- thermal expansion effects of the supporting wall and the System;
- likely local impact resistance;
- pull-through of fixings;
- pull-out of fixings;
- effect of wind loads on the System.

The System incorporates a subframe which is mechanically fixed to the supporting wall at maximum 600 mm centres.

During the assessment and survey, fixing pull-out strength (kN) tests shall be conducted on the supporting wall surface, in accordance with EOTA TR 051. The results of the assessment and survey assist the Agrément holder in determining the type, size and minimum number of fixings required. When using pull-out data for fixings, the material safety factor γ_m shall be considered.

Account shall be taken of Government Accredited Construction Details for Part L - Masonry external wall insulation illustrations, timber frame illustrations and steel frame illustrations for England and Wales and Accredited Construction Details for Scotland (hereinafter 'Government Accredited Construction Details').

2.2.2 Applied building physics (heat, air, moisture)

A Specialist shall check the hygrothermal behaviour of a project-specific design incorporating the System and, if necessary, offer advice on improvements to achieve the final specification. The Specialist can be either a qualified employee of the Agrément holder or a suitably qualified consultant (in which case it is recommended that the Specialist co-operates closely with the Agrément holder).

2.2.3 Permitted applications

Only applications designed according to the specifications given in this Agrément are permitted. In each case, the Specifier and Installer shall co-operate closely with the Agrément holder.

2.2.4 Installer competence level

The System shall be installed strictly in accordance with the instructions of the Agrément holder and the requirements of this Agrément.

Installation shall be by an Approved Installer, trained and approved by the Agrément holder.

2.2.5 Delivery, storage and site handling

The System components are delivered to site in suitable packaging bearing relevant identification information (for example, production identification code or batch number).

Prior to installation, the System components shall be stored in accordance with the Agrément holder's requirements. Good housekeeping protocols shall be followed to avoid damage.

Where required, particular care shall be taken to:

- avoid exposure to direct sunlight for extended periods of time;
- avoid exposure to high or low temperatures for extended periods of time;
- store components in a well-ventilated covered area to protect them from rain, frost and humidity;
- store away from possible ignition sources.

Detailed information regarding storage can be found in the System component manufacturer's guidelines.

2.2.6 Maintenance and repair

Once installed, the System does not require regular maintenance. For advice in respect of repair, consult the Agrément holder.

In normal conditions, cleaning will not be required as rain will periodically wash away dust, environmental dirt, etc. In cases where cleaning is required, panels shall be cleaned once per year with mineral spirits, organic cleaners or PH-neutral solvents.

Remove algae and fungi with a 5 % solution of hydrogen peroxide (H_2O_2) to eliminate all spores.

Performance factors in relation to the Major Points of Assessment

2.2.7 Moisture control

Condensation risk

External walls incorporating the System can adequately limit the risk of surface and interstitial condensation, when designed and constructed in accordance with BS 5250 and BRE Report 262.

A condensation risk analysis (hereinafter 'CRA') shall be completed at project-specific design stage for all elements of the construction, including at junctions, openings and penetrations to minimise the risk of surface and interstitial condensation. When correctly installed on an occupied building, no condensation will form on the internal wall. Based upon the result of the CRA, application of a VCL on the warm side of the insulation shall be considered.

Sheathing boards shall be covered with a breather membrane; if a breather membrane is omitted, water can penetrate a wall via taped butt joints, fasteners and penetrations (e.g. flues, ducts). Alternatively, the breather membrane could be placed on the ventilated side of the external wall insulation to meet project-specific requirements.

Vented profiles shall allow any residual trapped moisture from construction to escape, and openings in the base shall be small enough to prevent the ingress of birds, animals or small insects and shall be kept free of obstructions.

Resistance to precipitation including wind-driven rain

The project-specific design shall include detailing around openings, penetrations and movement joints to minimise the risk of wind-driven rainwater ingress, in accordance with BS 6093.

The System will provide a degree of protection against rainwater ingress across the drained and ventilated cavity to the supporting wall surface. However, care shall be taken to ensure that supporting walls are adequately weathertight prior to installation of the System. An approved watertight breathable membrane shall be installed to provide a secondary water ingress defence and contain the insulation.

The guidance given in BRE Report 262 shall be followed in connection with the weathertightness of wall constructions. The Agrément holder shall select a construction appropriate to the local wind-driven rain index, paying due regard to the design detailing, workmanship and materials to be used.

At the tops of walls, incorporating the System shall be protected by an adequate coping, overhang or other project-specific detail.

To contribute to the airtightness of the wall and reduce the risk of rain penetration:

- compartments shall be constructed to create pressure equalisation to limit rain penetration through the 10 mm wide (open) joints between wall cladding panels;
- a 50 mm wide air gap directly behind the wall cladding panels shall be included;
- the butt joints of sheathing boards and at interfaces with other building elements shall be taped or sealed;
- the (open) joints between the wall cladding panels shall be 10 mm wide.

Where openings are larger than 10 mm, a ventilation screen shall be provided to prevent birds and animals entering the cavity, e.g. at penetrations and at the top or bottom of the System.

Drainage deflection beads and EPDM membrane are incorporated into the System to deflect any water present in the drained and ventilated cavity around openings, penetrations or items that block the cavity.

The System has adequate resistance to artificial weathering and thermal shock, in accordance with EAD 040287-00-0404 and EAD 090062-00-0404.

2.2.8 Strength

The supporting wall shall have sufficient strength to withstand all wind and dead loads applied to and from the System, including racking and any temporary loads that could be applied during installation. The strength of the supporting wall shall be verified by a suitably qualified engineer. The project-specific design shall ensure that:

- the System attachment to the supporting wall has adequate fixing pull-out capacity for the calculated wind loads;
- thermal expansion effects of both, metal rails and metal structural frame are taken into consideration in the design and detailing.

The System shall be designed to withstand wind-action loads in accordance with BS EN 1991-1-1 / I.S. EN 1991-1-1 and BS EN 1991-1-4 / I.S. EN 1991-1-4. Account shall be taken of the location, shape and size of the building. The average yearly wind-load action data for the site location shall be collated and used to calculate the required design wind resistance (positive and negative) of a given support spacing, fixing pattern and sizes of vertical rails and brackets. Special consideration shall be given to locations with high wind-load pressure coefficients, as extra fixings may be required.

The supporting wall shall be designed in accordance with the relevant Standards to limit mid-span deflections to L/200 (mid-span) and L/150 (cantilever).

The qualified structural engineer shall ensure that the maximum design wind load achieved by the System, as per Table 2, shall be equal or less than the design pull-out resistance strength of the mechanical fixings from the supporting wall obtained from site tests.

Table 2 - Design wind load values

Design wind load [^] (kN/m ²)	Spacings		Design fixing pull-through resistance (kN) ^{^^}	
	Horizontal	Vertical		
2.90	560	210	0.188	Single span
1.33	560	575		
1.33	580	210	0.226	Double span
0.53	580	575		

[^] for single span, based on 600 mm by 2,400 mm board size; for double span, based on 1,200 mm by 2,400 mm board size; minimum horizontal edge distance 20 mm and minimum vertical edge distance 50 mm

^{^^} a safety factor of 2.5 has been applied

Positive wind load is transferred to the supporting wall directly via bearing and compression of the cladding panel, subframe and sheathing board through to the LGSF. Negative wind load is resisted by the mechanical fixing between cladding panel and subframe which is fixed to the supporting wall.

Impact resistance

When tested for hard- and soft-body impact resistance, in accordance with EAD 090062-00-0404, the System is categorised as Use Category III.

The Use Categories in accordance with EAD 090062-00-0404 are as detailed below:

- I - a zone readily accessible at ground level to the public and vulnerable to hard-body impacts but not subjected to abnormally rough use;
- II - a zone liable to impacts from thrown or kicked objects, but in public locations where the height of the System will limit the size of the impact; or at lower levels where access to the building is primarily to those with some incentive to exercise care;
- III - a zone not likely to be damaged by normal impacts caused by people or by thrown or kicked objects;
- IV - a zone out of reach from ground level.

2.2.9 Fire performance

When incorporating MW insulation and A1 sheathing boards, the reaction to fire of the System is classified as European Classification A2-s1, d0, in accordance with BS EN 13501-1.

The following components of the System are classified as A1, without need of further testing (CWFT) in accordance with European Directive 96/603/EC and BS EN 13501-1:

- LGSF;
- subframe;
- MW insulation;
- RCM Y-wall and RCM Multipurpose sheathing boards.

The following components of the System are classified in accordance with BS EN 13501-1 as follows:

- PF insulation - European Classification C-s1, d0;
- RCM Cemboard sheathing board - European Classification B-s1, d0;
- RockPanel A2 cladding panel - European Classification A2-s1, d0.

When incorporating MW insulation and A1 sheathing boards, the System can be used on buildings without any restrictions on building height or boundaries, in accordance with the national Building Regulations.

Construction materials, components and associated attachments used in the overall wall construction shall satisfy the requirements of Regulations 7(2) and 7(3) (for England and Wales), Regulations 8(3) and 8(4) (for Scotland) and Regulations 23(2) and 23(3) (for Northern Ireland). Designers shall refer to the national Building Regulations for further details.

When incorporating PF insulation and/or RCM Cemboard sheathing board, the System can be used on buildings with height and boundary restrictions in accordance with the national Building Regulations, as follows:

- for non-residential buildings in England, Wales and Northern Ireland, the System shall not be used on buildings with a storey of 18 m or more above ground level; the System can be used without any boundary restrictions. Refer to the relevant national Building Regulations for types of buildings and any exclusions that may apply;
- for residential buildings in England, Wales, Northern Ireland and all buildings in Scotland, the System is restricted to buildings with no floor more than 11 m above ground and not less than 1 m from the boundary. In such cases the System may be excluded from the unprotected area calculation regardless of openings. Refer to the national Building Regulations for types of buildings and any exclusions that may apply;
- for dwellings in Ireland, the System shall not be used on buildings with a storey of 15 m or more above ground level; the System can be used without any boundary restrictions. Refer to the relevant national Building Regulations for types of buildings and any exclusions that may apply;
- for buildings other than dwellings in Ireland, the System shall not be used on buildings with a storey of 18 m or more above ground level; the System can be used without any boundary restrictions. Refer to the national Building Regulations for types of buildings and any exclusions that may apply.

The fire resistance of walls is based on the occupancy, size and use of a building and shall be a minimum of 30 minutes. It is then specified in 60-minute intervals thereafter.

The System shall include a minimum of one stainless steel fixing per m² of insulation or per insulation board, whichever is the lesser, in addition to the other insulation fasteners normally specified from 1st storey and above. These fixings shall be fixed to the LGSF supporting wall through the sheathing board or fixed to the sheathing board.

Cavity fire barriers shall be installed in line with compartment walls and floors, as advised in BRE Report 135 and as required under the national Building Regulations. Materials used for cavity barriers and firestops shall be capable of producing adequate resistance to fire and smoke. Intumescent strips shall be applied on the ventilated side of each fire barrier.

Walls shall be designed and constructed:

- to adequately resist the passage and penetration of fire;
- so that the unseen spread of fire and smoke within concealed spaces in the wall is inhibited.

For detailed conditions of use regarding requirements for supporting wall fire performance and fire barriers, fire stopping of service penetrations and combustibility limitations for other materials and components used in the overall wall construction, designers shall refer to the relevant national Building Regulations.

Proximity of flues and appliances

When incorporating PF insulation, the installed System shall be adequately separated from any chimney, heat-producing appliance or incinerator flue pipes passing through a wall. Recommended means of separation are detailed in the Approved Documents supporting the national Building Regulations.

2.2.10 Thermal performance

The System can assist in reducing the U-value of external walls. It is essential that detailing is carried out to a high standard if the ingress of water into the MW or PF insulation is to be avoided and the full thermal benefit is to be obtained from the installation of the System. Any moisture penetration will affect thermal conductivity; the thermal value will recover when the insulation dries out. The System is designed to minimise moisture penetration to the insulation.

The requirement for limiting heat loss through the building fabric, including the effect of thermal bridging, can be satisfied if the U-value of a wall incorporating the System does not exceed the maximum U-value requirement given in the national Building Regulations.

The U-value of a completed wall construction will depend on the insulation type and thickness, degree of ventilation to the drained cavity, fixing method, type of mechanical fixing, sheathing board and insulating value of the supporting wall and its internal finish.

For the purposes of U-value calculations and to determine if the requirements of national Building Regulations are met, the thermal resistance and U-value of the walls incorporating the System shall be calculated according to BS EN ISO 10211 (taking into consideration BS EN ISO 6946, BS EN ISO 10456 and BRE Report 443), using the thermal conductivity (λ_D) of the insulations, thermal pads and sheathing boards (refer to Section 2.5.4), and for other components of the System using designed thermal conductivity (λ) values, in accordance with BS EN 12524.

Thermal bridging at junctions and around openings

Care shall be taken in the overall design and construction of junctions with other elements and openings to minimise cold bridging and air infiltration. Due consideration shall be given to the Government Accredited Construction Details.

Isolator pads shall be used to minimise thermal bridges caused by System brackets and rails.

Guidance on linear thermal transmittance, heat flows and surface temperatures can be found in the documents supporting the national Building Regulations and in BS EN ISO 10211, BRE Information Paper 1/06, BRE Report 262, BRE Report 497, PAS 2030 and PAS 2035.

2.2.11 Durability

The service life durability of the System will be dependent upon the environment (operating conditions) in which the System will be used. The expected service life durability will be in excess of 30 years.

Once installed, the System is not susceptible to damage from environmental conditions normally encountered in the UK and Ireland.

2.2.12 UKCA, UKNI and CE marking

There is no relevant Product standard for the System.

2.3 EXAMPLES OF TYPICAL DETAILS

Diagram 1 - Bracket F1

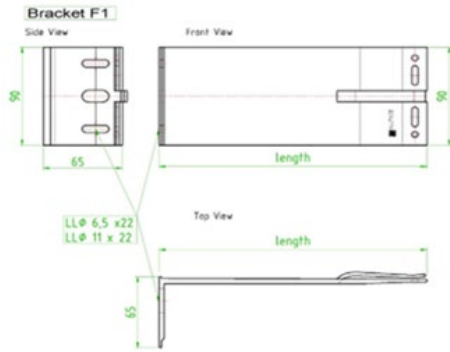

Diagram 2 - Bracket F1+

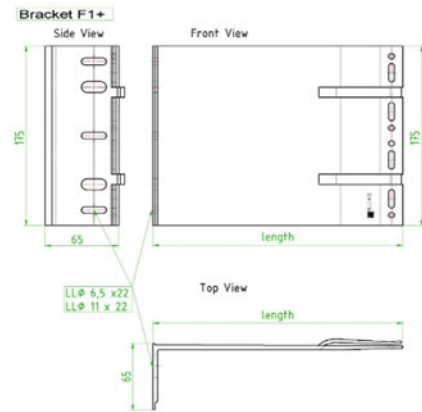

Diagram 3 - Typical insulation fixing pattern

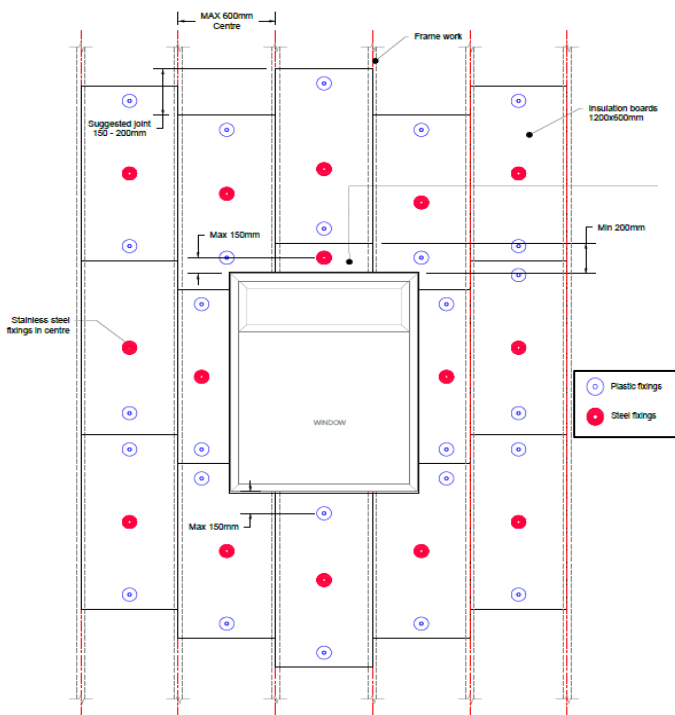

Diagram 4 - Plan view - typical construction detail of the System with the breather membrane installed on the external side of the sheathing board

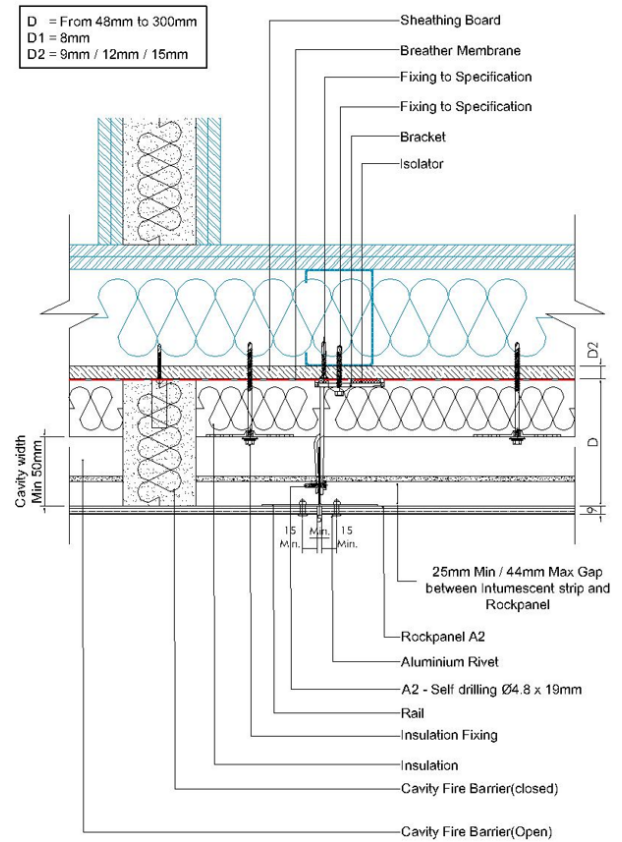

Diagram 5 - Plan view - typical construction detail of the System with the breather membrane installed on the ventilated side of the insulation

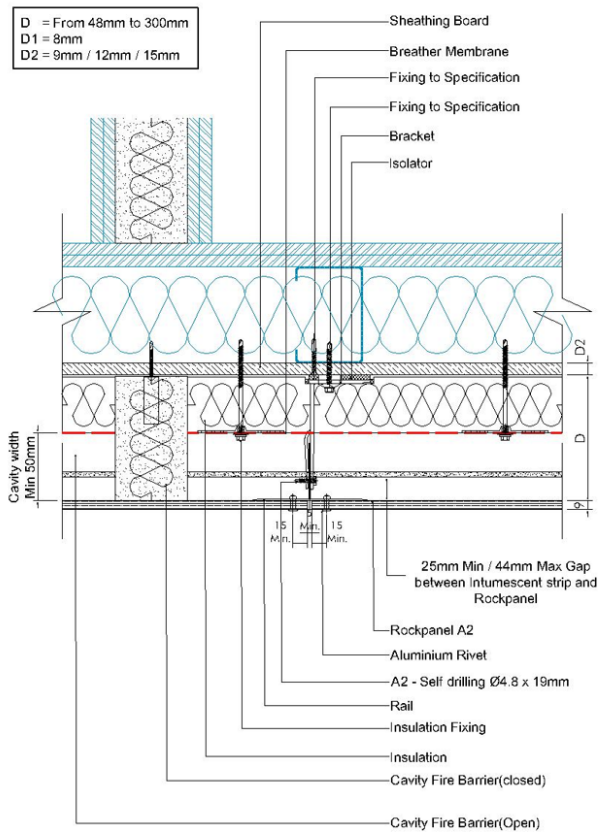

Diagram 6 - Typical horizontal movement joint detail

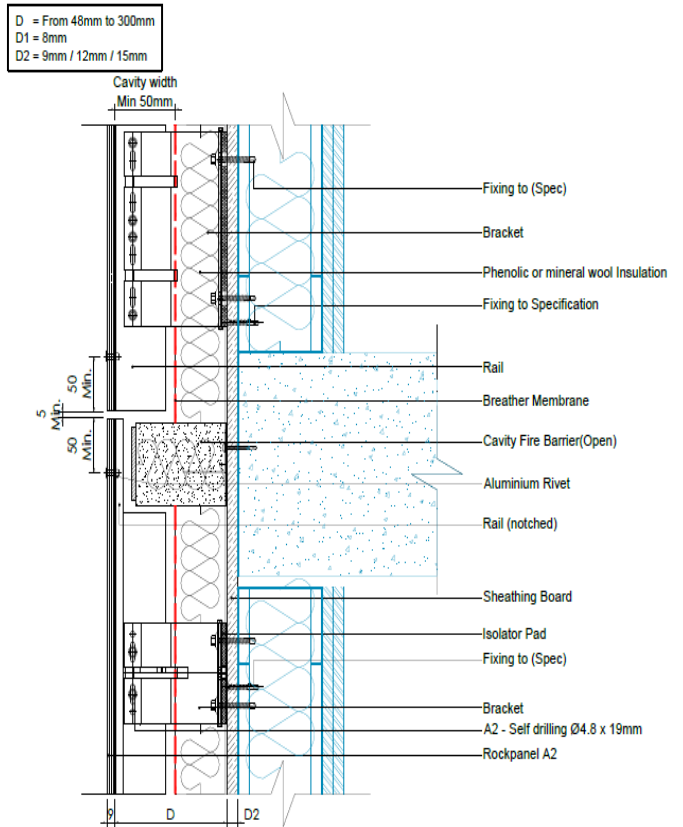

Diagram 7 - Typical window jamb detail

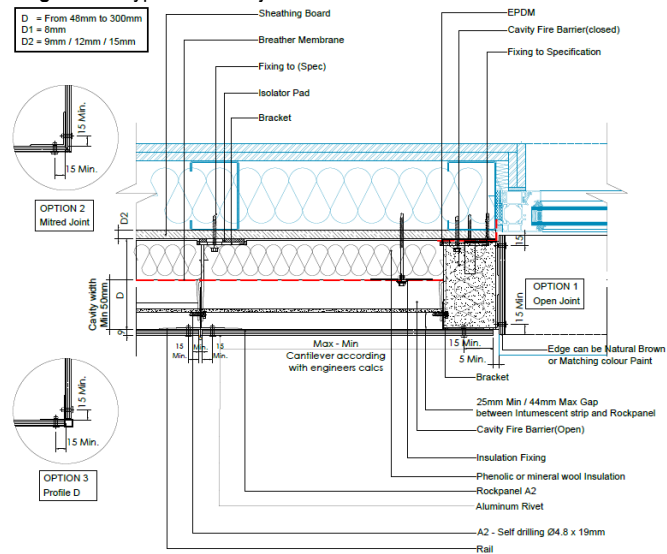

Diagram 8 - Typical window cill detail

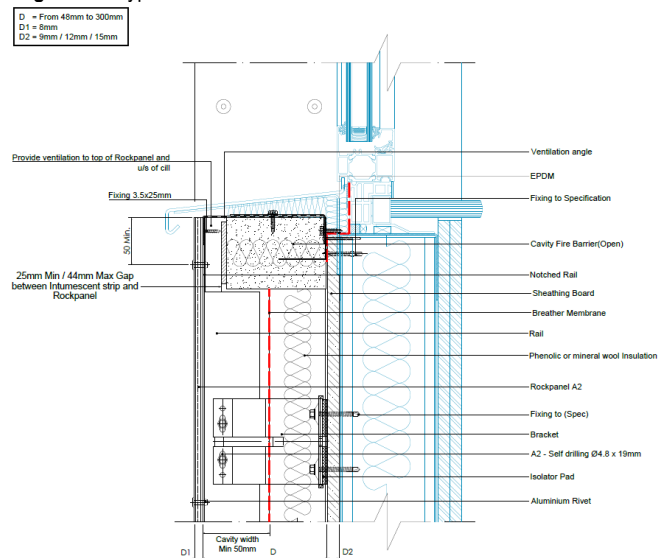

Diagram 9 - Typical window head detail

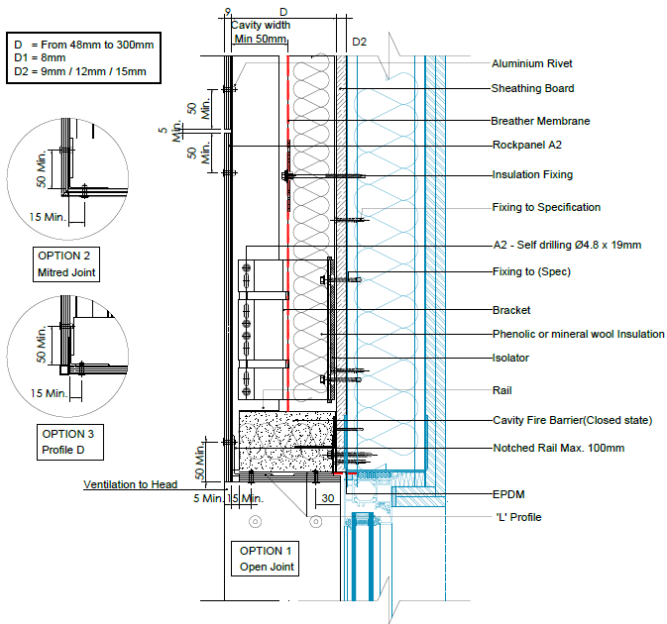

Diagram 10 - Typical base detail

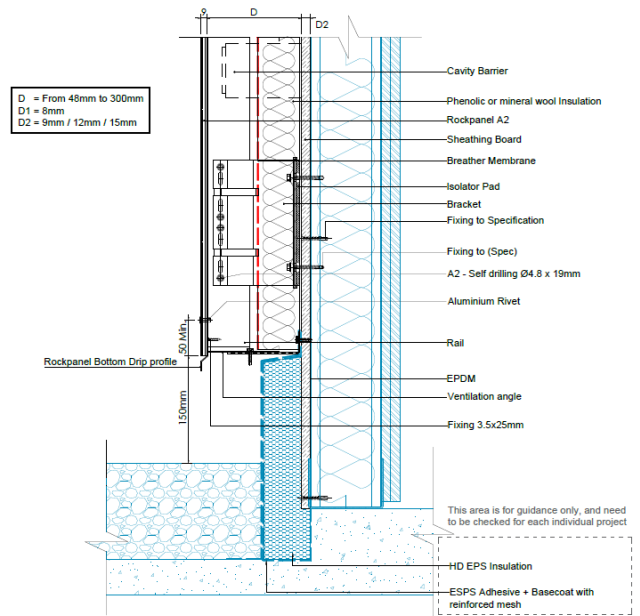

Diagram 11 - Typical internal corner fixed detail

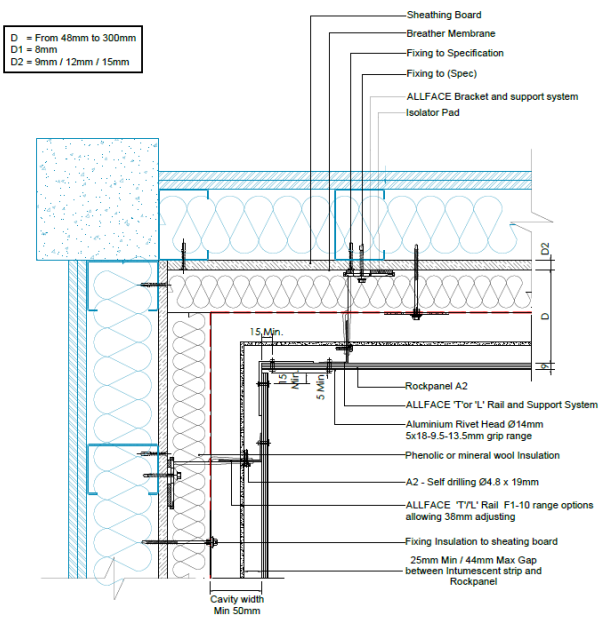

Diagram 12 - Typical external corner cantilever detail

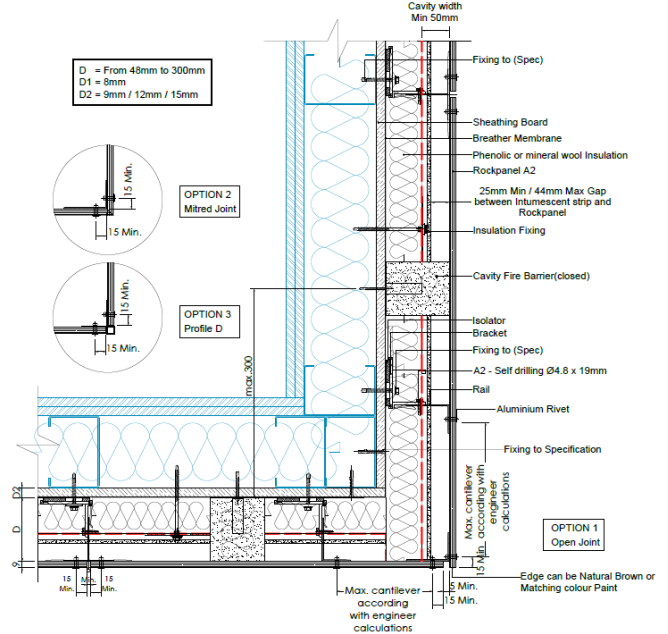

Diagram 13 - Typical soffit detail

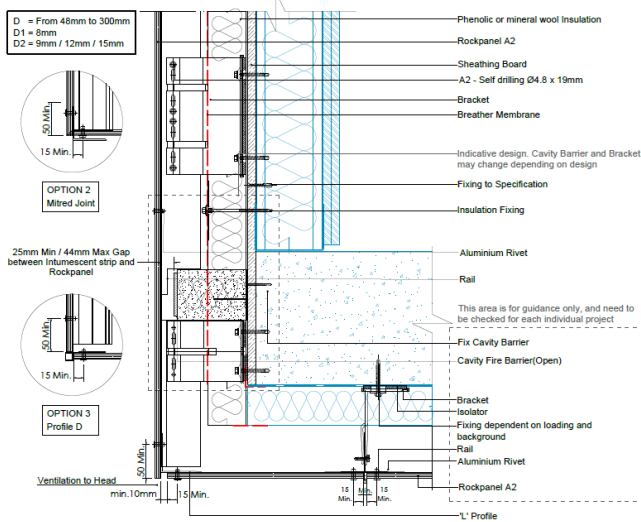
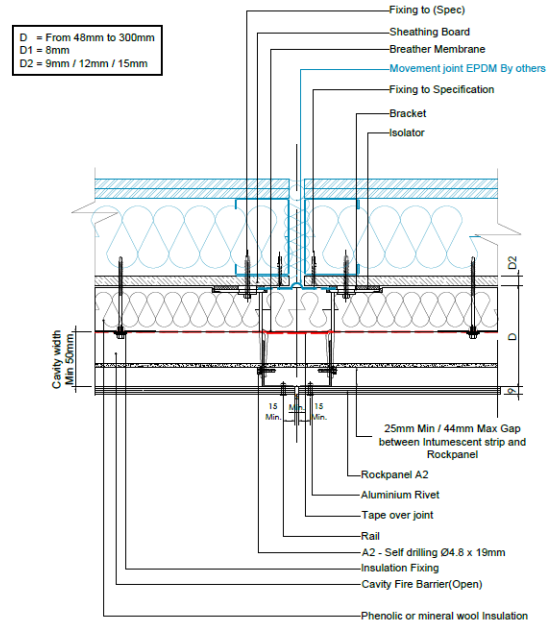

Diagram 14 - Movement joint vertical detail



Notes:

- items in blue colour are outside the scope of this Agrément;
- the diagrams show typical construction details of the System, irrespective of the position of the breather membrane (which can be installed as per Diagrams 4 or 5).

2.4 INSTALLATION

The System shall be installed strictly in accordance with the instructions (hereinafter 'Installation Manual') of the Agrément holder, the requirements of this Agrément and the requirements of BS 8000-0.

2.4.1 Project-specific installation considerations

The project-specific design shall be determined from a pre-installation survey.

A specification shall be prepared for each elevation of the building indicating, where appropriate:

- DPC level, the position of vented profile, water deflection beads/rails, expansion joints and weather seals;
- detailing around windows, doors, etc.;
- identification of:
 - services and any fittings requiring removal or alteration to facilitate installation of the System;
 - areas where silicone/flexible sealants shall be used.

The installation process includes fixing pull-out tests of the supporting wall according to the Construction Fixings Association Guidance Note 'Procedure for site testing construction fixings', to determine pull-out strength values (see Section 2.2.1.4). Pull-out test loads shall be 2.5 x design load. The design pull-out resistance strengths of the supporting wall, brackets, rails and cladding panels shall be checked by a competent person and evidenced to be adequate before installation of the System.

Subsequent project-specific design considerations include confirmation that:

- there is no existing rising damp and there are no signs of damp on the inner face of the supporting wall, other than those caused solely by condensation;
- existing walls are:
 - structurally sound, in a good state of repair and show no evidence of rain or frost damage;
 - watertight, clean and meet the requirements of the relevant Standards and national Building Regulations for airtightness.

2.4.2 Preparation

The following considerations apply before starting the work:

- the supporting wall shall be finished and free from protrusions and uneven jointing;
- any necessary repairs or modifications (e.g. removal of fittings which can be relocated after the System is installed);
- the roof shall be in place and window and door openings sealed;
- surfaces shall be clean, dry and free from dirt, grease, oils, solvents and loose particles;
- flues, chimneys and combustion air ventilators shall be continuously sleeved through the wall. Reference shall be made to CIGA's 'Technician's guide to best practice: Flues, chimneys and combustion air ventilators';
- supports for services/fittings, e.g. soil pipes, shall be fixed back to the supporting wall; no load is to be transferred to the System;
- external power cables covered by cover plates shall be well labelled with warning signs;
- adequate access to the construction site, parking and unloading of vehicles shall be provided;
- appropriate storage of System components, tools and on-site transport from storage to wall shall be provided, where required;
- provision of necessary lifting equipment (such as scaffolding or aerial).

The following works shall be undertaken before installing the System:

- the minimum distances of the centre of a rivet hole to a vertical edge and to a horizontal edge are 20 mm and 50 mm respectively, all rivet holes in a panel shall have a diameter of 8.5 mm, while holes in the vertical rails shall have a diameter of 5.1 mm.

2.4.3 Outline installation procedure

Detailed installation procedures can be found in the Agrément holder's Installation Manual.

The outline procedure is as follows:

- install the sheathing boards to LGSF, taking care to avoid four-way joints by staggering the boards, using wing-tip 4.8 mm by 38 mm fasteners using a maximum 600 mm by 300 mm grid pattern;
- tape the joints between sheathing boards using illbruck ME315 tape to create an airtight layer;
- if required, cut holes in the sheathing board for installation of a protection pipe for service penetrations;
- install the breather membrane on top of the sheathing boards, with strips of EPDM membrane and adhesive to create an airtight and weatherproof wall-window interface; alternatively, and depending on the project-specific requirements, the breather membrane can be installed on the ventilated side of the insulation;
- install the subframe brackets to the sheathed LGSF supporting wall using 6.3 mm by 50 mm mechanical fixings through isolator pads and sheathing board;
- install the MW or PF insulation board and fasten with plastic and stainless-steel washers and steel 4.8 mm diameter fixings;
- a minimum of one non-combustible fixing per 1m² or per insulation batt, (whichever is the lesser), shall be provided in addition to the other fixings;
- install the subframe vertical rails (L/T-profiles) and mechanically fix to the subframe bracket, using 19 mm mechanical fasteners;
- install cavity barriers in the cavities and around openings or use cavity closers;
- install the cladding panels in a portrait or landscape orientation using vacuum handles with silicone cups to be fixed by 5.0 mm by 18 mm rivets. Secure every panel by starting with two fixed points using fixed point sleeves.

2.4.4 Finishing

The following finishing is required on completion of the installation:

- clean the System to remove any staining sustained during installation:
 - for non-calcium-based stains, remove dust with water at a maximum pressure of 80 bar;
 - for calcium-based stains, apply a mist spray of a solution of 10 % acetic acid in water;
 - for rust and other metal stains, use hydrochloric acid (5 %) or similar detergent.

2.5 INDEPENDENTLY ASSESSED SYSTEM CHARACTERISTICS

2.5.1 Moisture control

Test	Standard	Component	Result
Water vapour transmission	BS EN ISO 12572	Breather membrane (Illbruck ME010)	$S_d = 0.112$ m
		Breather membrane (Proctor Wraptite)	$S_d = 0.039$ m (wet cup)
		Breather membrane (Thermic Technology Ltd PhotonWrap)	$S_d = 0.019$ m (wet cup)
		Sheathing board (RCM Y-wall)	$S_d = 0.341$ m
		Sheathing board (RCM Multipurpose)	$S_d = 0.63$ m
		Sheathing board (RCM Cemboard)	$S_d = 1.37$ m
	BS EN ISO 10456	MW insulation (Knauf Rocksilk Rainscreen slab)	$\mu = 1$
		MW insulation (Rockwool Rainscreen Duo slab)	$\mu = 1$
		PF insulation (Kingspan Kooltherm K15)	$\mu = 50$
Water penetration	BS EN 1928	Breather membrane (Illbruck ME010)	W1
		Breather membrane (Proctor Wraptite)	W1
	BS EN 13111	Breather membrane (Thermic Technology Ltd PhotonWrap)	W2
Water absorption, W_p	BS EN ISO 29767	MW insulation (Knauf Rocksilk Rainscreen slab)	< 1 kg/m ²
		MW insulation (Rockwool Rainscreen Duo slab)	1.41 kg/m ²
		PF insulation (Kingspan Kooltherm K15)	1.01 kg/m ²

2.5.2 Strength

Test	Standard	Component	Result*	
Rivet - pull through from panel ^{^^}	EAD 090062-00-0404	Assembly comprising RockPanel A2 cladding panel (9 mm thick), aluminium rail profile (2 mm thick) and Rockpanel 5.0 x 18 - K14 rivets	Centre of panel	$F_k = 935$ N
			≥ 20 mm from edge of panel	$F_d = 468$ N
			$\geq 20/50$ mm from corner of panel	$F_k = 608$ N
				$F_d = 304$ N
Rivet - pull out strength		Assembly comprising 2 mm thick aluminium profile and Rockpanel 5.0 x 18 - K14 rivets	$F_k = 3,360$ N [§]	
Soft-body impact		Rockpanel cladding panel (9 mm thick)	10 J (Use Category III)	
Hard-body impact				
Shear strength		Subframe fastener - rail to bracket (Ejot JT4-4-4.8x19)	$F_k = 5,160$ N ^{§§}	
Compressive strength	BS EN 826	PF insulation (Kingspan Kooltherm K15)	100 kPa	

^{*} the notations F_m , F_k and F_d refer to mean, characteristic and design values respectively

^{^^} material factor of 2 for Rockpanel to be used for calculation of design loads

[§] safety factor of 3 for rivets to be used for calculation of design loads

^{§§} safety factor of 1.9 for subframe fasteners to be used for calculation of design loads

2.5.3 Fire performance

Test	Standard	Component	Result
Reaction to fire	BS EN 13501-1	RockPanel A2 Rain Screen Cladding System with MW insulation [^]	A2-s1, d0
		RockPanel A2 panel	A2-s1, d0
		Sheathing board (RCM Y-wall)	A1
		Sheathing board (RCM Multipurpose)	A1
		Sheathing board (RCM Cemboard)	B-s1, d0
		Breather membrane (Illbruck ME010)	B-s3, d0
		Breather membrane (Proctor Wraptite)	B-s1, d0
		Breather membrane (Thermic Technology Ltd PhotonWrap)	A1
		MW insulation (Knauf Rocksilk Rainscreen slab)	A1
		MW insulation (Rockwool Rainscreen Duo slab)	A1
		PF insulation (Kingspan Kooltherm K15)	C-s2, d0

[^] tested configuration comprising RockPanel A2 board, aluminium rivets, aluminium studs grade AW6060, 20 mm ventilated air gap and 50 mm Rockwool Premium MW insulation

2.5.4 Thermal performance

Test	Standard	Component	Result
Thermal conductivity (λ_D)	BS EN 12667	Knauf Rocksilk Rainscreen Slab, 50 mm to 210 mm thick	0.034 W/mK
		Rockwool Rainscreen Duo Slab < 90 mm thick	0.034 W/mK
		Rockwool Rainscreen Duo Slab ≥ 90 mm thick	0.035 W/mK
		Kingspan Kooltherm K15, thickness 25 to 44 mm thick	0.022 W/mK
		Kingspan Kooltherm K15, thickness 45 to 150 mm thick	0.021 W/mK
		Isolator pads - 5 mm thick	0.195 W/mK
	-	Isolator pads - AllFace	0.40 - 0.49 W/mK
	BS EN 12667	Sheathing board (RCM Y-wall)	0.195 W/mK
	ISO 8302	Sheathing board (RCM Multipurpose)	0.119 W/mK
		Sheathing board (RCM Cemboard)	0.240 W/mK

3.1 THE CONSTRUCTION (DESIGN AND MANAGEMENT) REGULATIONS 2015 AND THE CONSTRUCTION (DESIGN AND MANAGEMENT) REGULATIONS (NORTHERN IRELAND) 2016

Information in this Agrément may assist the client, principal designer/CDM co-ordinator, designer and contractors to address their obligations under these Regulations.

3.2 THE NATIONAL BUILDING REGULATIONS

In the opinion of Kiwa Ltd., the System, if installed and used in accordance with Section 2 of this Agrément, can satisfy or contribute to satisfying the relevant requirements of the following national Building Regulations.

This Agrément shall not be construed to confer the compliance of any project-specific design with the national Building Regulations.

3.2.1 England**The Building Regulations 2010 and subsequent amendments**

- A1(1)(a) Loading - the System can sustain and transmit combined self-weight and wind loads to the ground via a supporting wall
- B3(4) Internal fire spread (structure) - the System incorporating cavity barriers can inhibit the spread of fire and smoke
- B4(1) External fire spread - the System can adequately resist the spread of fire over walls. The fire classification of the System is dependent upon the elements selected
- C2(b) Resistance to moisture - the System can adequately protect a building from precipitation, including wind-driven spray
- C2(c) Resistance to moisture - the System can adequately protect a building from interstitial and surface condensation
- L1(a)(i) Conservation of fuel and power - the System can contribute to limiting heat gains and losses through a wall
- Regulation 7(1) Materials and workmanship - the System is manufactured from suitably safe and durable materials for their application, and can be installed to give a satisfactory performance
- Regulation 7(2) Materials and workmanship - all System components which are part of the external wall or specified attachment, shall achieve European classification of A2-s1, d0 or A1
- Regulation 23 Requirements relating to thermal elements - the System can contribute to walls complying with the requirements of L1(a)(i)
- Regulation 26 CO₂ emission rates for new buildings - the System can contribute to satisfying this Requirement
- Regulation 26A Fabric energy efficiency rates for new dwellings - the System can contribute to satisfying this Requirement (for dwellings only)
- Regulation 26C Target primary energy rates for new buildings - the System can contribute to satisfying this Requirement

3.2.2 Wales**The Building Regulations 2010 and subsequent amendments**

- A1(1)(a) Loading - the System can sustain and transmit combined self-weight and wind loads to the ground via a supporting wall
- B3(4) Internal fire spread (structure) - the System incorporating cavity barriers can inhibit the spread of fire and smoke
- B4(1) External fire spread - the System can adequately resist the spread of fire over walls. The fire classification of the System is dependent upon the elements selected
- C2(b) Resistance to moisture - the System can adequately protect a building from precipitation, including wind-driven spray
- C2(c) Resistance to moisture - the System can adequately protect a building from interstitial and surface condensation
- L1(a)(i) Conservation of fuel and power - the System can contribute to limiting heat gains and losses through a wall
- Regulation 7(1) Materials and workmanship - the System is manufactured from suitably safe and durable materials for their application, and can be installed to give a satisfactory performance
- Regulation 7(2) Materials and workmanship - all System components which are part of the external wall or specified attachment, shall achieve European classification of A2-s1, d0 or A1
- Regulation 23 Requirements relating to thermal elements - the System can contribute to walls complying with the requirements of L1(a)(i)
- Regulation 26 CO₂ emission rates for new buildings - the System can contribute to satisfying this Requirement
- Regulation 26A Primary energy rates for new buildings (for non-domestic buildings only) - the System can contribute to satisfying this Requirement
- Regulation 26B Fabric performance values for new dwellings - the System can contribute to satisfying this Requirement
- Regulation 26C Energy efficiency rating - the System can contribute to satisfying this Requirement

3.2.3 Scotland**The Building (Scotland) Regulations 2004 and subsequent amendments****3.2.3.1 Regulation 8 (1)(2) Durability, workmanship and fitness of materials**

- The System is manufactured from acceptable materials and is adequately resistant to deterioration and wear under normal service conditions, provided it is installed in accordance with the requirements of this Agrément

3.2.3.2 Regulation 8 (3) Durability, workmanship and fitness of materials

- All System components which are part of the external wall or specified attachment, shall achieve European classification of A2-s1, d0 or A1

3.2.3.3 Regulation 9 Building Standards - Construction

- 1.1(a)(b) Structure - the System can sustain and transmit combined dead, imposed and wind loads to the ground via the supporting structure
- 2.4 Cavities - the System incorporating cavity barriers can inhibit the unseen spread of fire and smoke within concealed spaces
- 2.6 Spread to neighbouring buildings - the System can inhibit the spread of fire to neighbouring buildings
- 2.7 Spread on external walls - the System can inhibit the spread of fire on external walls
- 2.8 Spread from neighbouring buildings - the System can inhibit the spread of fire to the building
- 3.10 Precipitation - the System can resist precipitation penetrating to the inner face of the building
- 3.15 Condensation - the System can be designed and constructed to inhibit surface or interstitial condensation
- 6.1(b) Carbon dioxide emissions - the System can contribute to satisfying this Requirement
- 6.2 Buildings insulation envelope - the System can contribute to satisfying this Requirement

- 7.1(a)(b) Statement of sustainability - the System can contribute to meeting the relevant Requirements of Regulation 9, Standards 1 to 6, and therefore will contribute to a construction meeting a bronze level of sustainability as defined in this Standard. In addition, the System can contribute to a construction meeting a higher level of sustainability, as defined in this Standard

3.2.3.4 Regulation 12 Building Standards - Conversions

- All comments given under Regulation 9 also apply to this Regulation, with reference to Schedule 6 of The Building (Scotland) Regulations 2004 and subsequent amendments, clause 0.12 of the Technical Handbook (Domestic) and clause 0.12 of the Technical Handbook (Non-Domestic)

3.2.4 Northern Ireland

The Building Regulations (Northern Ireland) 2012 and subsequent amendments

- 23(1)(a)(i)(ii)(iii)(b) Fitness of materials and workmanship - the System is manufactured from materials which are suitably safe and acceptable as described in this Agrément
- 23(2) Fitness of materials and workmanship - all System components which are part of the external wall or specified attachment, shall achieve European classification of A2-s1, d0 or A1
- 28(b) Resistance to moisture and weather - the System can be constructed to prevent the passage of moisture
- 29 Condensation - the System can be designed and constructed to prevent interstitial condensation
- 30(a) Stability - the System can sustain and transmit combined dead, imposed and wind loads to the ground via the supporting structure
- 35(4) Internal fire spread (structural) - the System incorporating cavity barriers can inhibit the unseen spread of fire and smoke within concealed spaces
- 36(a) External fire spread - the System can adequately resist the spread of fire over walls and from one building to another
- 39(a)(i) Conservation measures - the System can contribute to limiting heat gains and losses through walls
- 40(2) Target CO₂ emission rate - a wall incorporating the System shall be designed and constructed as not to exceed its target CO₂ emission rate
- 43 Renovation of thermal elements - the renovation work carried out to ensure the wall complies with requirement 39(a)(i)

3.2.5 Ireland

Building Regulations 1997 and subsequent amendments

In order to demonstrate compliance with Irish Building Regulations, this BDA Agrément® certifies that the System complies with the requirements of a recognised document and indicates it is suitable for its intended purpose and use.

- A1(1)(a) Structure - the System can sustain and transmit combined dead and wind loads to the supporting wall
- B3(3) Internal fire spread (structural) - the System incorporating cavity barriers can inhibit the unseen spread of fire and smoke within concealed spaces
- B4 External fire spread - the System can adequately resist the spread of fire over walls and from one building to another
- B8(3) Internal fire spread (structural) - the System incorporating cavity barriers can contribute to inhibit the unseen and smoke within concealed spaces
- B9 External fire spread - the System can adequately resist the spread of fire over walls and from one building to another
- C4 Resistance to weather and ground moisture - a wall incorporating the System can contribute to adequately protecting a building from the passage of moisture from precipitation and condensation
- D1 Materials and workmanship - the System is manufactured from suitably safe and durable materials for their application, and can be installed to give a satisfactory performance
- L1 Conservation of fuel and energy - the System can contribute to limiting heat gains and losses through walls
- L2(a) Conservation of fuel and energy (in existing dwellings) - the System can contribute to limiting heat gains and losses through walls
- L4(a) Conservation of fuel and energy (in existing buildings other than dwellings) - the System can contribute to limiting heat gains and losses through walls
- L5(c) Conservation of fuel and energy (in new buildings other than dwellings) - the System can contribute to limiting heat gains and losses through walls
- Regulation 7 Conservation of fuel and energy in existing dwellings - the System can contribute to satisfying this Requirement
- Regulation 8(c) Conservation of fuel and energy in new dwellings - the System can contribute to satisfying this Requirement

3.3 THIRD-PARTY ACCEPTANCE

None requested by the Agrément holder.

- BS EN ISO 6946:2017 Building components and building elements. Thermal resistance and thermal transmittance. Calculation methods
- BS EN ISO 9001:2015 Quality management systems. Requirements
- BS EN ISO 10211:2017 Thermal bridges in building construction. Heat flows and surface temperatures. Detailed calculations
- BS EN ISO 10456:2007 Building materials and products. Hygrothermal properties. Tabulated design values and procedures for determining declared and design thermal values
- BS EN ISO 12572:2016 Hygrothermal performance of building materials and products. Determination of water vapour transmission properties. Cup method
- BS EN ISO 29767:2019 Thermal insulating products for building applications. Determination of short-term water absorption by partial immersion
- BS EN 573-3:2019+A1:2022 Aluminium and aluminium alloys. Chemical composition and form of wrought products. Chemical composition and form of products
- BS EN 826:2013 Thermal insulating products for building applications. Determination of compression behaviour
- BS EN 1928:2000 Flexible sheets for waterproofing. Bitumen, plastic and rubber sheets for roof waterproofing. Determination of watertightness
- BS EN 1991-1-1:2002 Eurocode 1. Actions on structures - General actions. Densities, self-weight, imposed loads for buildings
- NA to BS EN 1991-1-1:2002 UK National Annex to Eurocode 1. Actions on structures - General actions. Densities, self-weight, imposed loads for buildings
- BS EN 1991-1-4:2005+A1:2010 Eurocode 1. Actions on structures. General actions. Wind actions
- NA to BS EN 1991-1-4:2005+A1:2010 UK National Annex to Eurocode 1. Actions on structures. General actions. Wind actions
- BS EN 1993-1-1:2005+A1:2014 Eurocode 3. Design of steel structures. General rules and rules for buildings
- NA+A1:2014 to BS EN 1993-1-1:2005+A1:2014 UK National Annex to Eurocode 3. Design of steel structures. General rules and rules for buildings
- BS EN 1993-1-3:2006 Eurocode 3. Design of steel structures. General rules. Supplementary rules for cold-formed members and sheeting
- NA to BS EN 1993-1-3:2006 UK National Annex to Eurocode 3. Design of steel structures. General rules. Supplementary rules for cold-formed members and sheeting
- BS EN 12467:2012+A2:2018 Fibre-cement flat sheets. Product specification and test methods
- BS EN 12524:2000 Building materials and products. Hygrothermal properties. Tabulated design values
- BS EN 12667:2001 Thermal performance of building materials and products. Determination of thermal resistance by means of guarded hot plate and heat flow meter methods. Products of high and medium thermal resistance
- BS EN 13111:2010 Flexible sheets for waterproofing. Underlays for discontinuous roofing and walls. Determination of resistance to water penetration
- BS EN 13162:2012+A1:2015 Thermal insulation products for buildings. Factory made mineral wool (MW) products. Specification
- BS EN 13166:2012+A2:2016 Thermal insulation products for buildings. Factory made phenolic foam (PF) products. Specification
- BS EN 13501-1:2018 Fire classification of construction products and building elements. Classification using data from reaction to fire tests
- BS EN 13859-2:2014 Flexible sheets for waterproofing. Definitions and characteristics of underlays. Underlays for walls
- BS EN 13986:2004+A1:2015 Wood-based panels for use in construction. Characteristics, evaluation of conformity and marking
- BS 5250:2021 Management of moisture in buildings. Code of practice
- BS 6093:2006+A1:2013 Design of joints and jointing in building construction. Guide
- BS 8000-0:2014 Workmanship on construction sites. Introduction and general principles
- BS 8104:1992 Code of practice for assessing exposure of walls to wind-driven rain
- Accredited Construction Details, Scotland:2019
- BRE Information Paper 1/06:2006 Assessing the effects of thermal bridging at junctions and around openings
- BRE Report 135:2013 Fire performance of external thermal insulation for walls of multi-storey buildings
- BRE Report 262:2002 Thermal insulation: avoiding risks
- BRE Report 443:2019 Conventions for U-value calculations
- BRE Report 497:2016 Conventions for calculating linear thermal transmittance and temperature factors
- Construction Fixings Association Guidance note:2012 Procedure for site testing construction fixings
- EAD 040287-00-0404:2017 Kits for external thermal insulation composite systems (ETICS) with panels as thermal insulation product and discontinuous claddings as exterior skin
- EAD 090001-00-0404:2015 Pre-fabricated compressed mineral wool boards with organic or inorganic finish and with specified fastening system
- EAD 090062-00-0404:2018 Kits for external wall cladding mechanically fixed
- EOTA TR 051:2018 Recommendations for job site tests of plastic anchors and screws
- Government Accredited Construction Detail for Part L:2019
- I.S. EN 1991-1-1:2002 Eurocode 1: Actions on structures. Part 1-1: General actions. Densities, self-weight, imposed loads for buildings
- I.S. EN 1991-1-1:2002/NA:2013 Irish National Annex to Eurocode 1: Actions on structures. Part 1-1: General actions. Densities, self-weight, imposed loads for buildings
- I.S. EN 1991-1-4:2005 Eurocode 1: Actions on structures. Part 1-4: General actions. Wind actions
- I.S. EN 1991-1-4/NA:2005 Irish National Annex to Eurocode 1: Actions on structures. Part 1-4: General actions. Wind actions
- I.S. EN 1993-1-1:2005 Eurocode 3: Design of steel structures. Part 1-1: General rules and rules for building
- I.S. EN 1993-1-1/NA:2005 Irish National Annex (Informative) to Eurocode 3: Design of steel structures. Part 1-1: General rules and rules for building
- I.S. EN 1993-1-3:2006 Eurocode 3: Design of steel structures. Part 1-3: General rules. Supplementary rules for cold-formed members and sheeting
- I.S. EN 1993-1-3/NA:2006 Irish National Annex to Eurocode 3: Design of steel structures. Part 1-3: General rules. Supplementary rules for cold-formed members and sheeting
- ISO 8302:1991 Thermal insulation. Determination of steady-state thermal resistance and related properties. Guarded hot plate apparatus
- PAS 2030:2019+A1:2022 Specification for the installation of energy efficiency measures in existing buildings
- PAS 2035:2019+A1:2022 Retrofitting dwellings for improved energy efficiency. Specification and guidance

Remark - Apart from these sources, technical information and confidential reports have been assessed; any relevant documents are in the possession of Kiwa Ltd. and are kept in the Technical Assessment File of this Agrément. The Installation Manual for the System may be subject to change; contact the Agrément holder for the clarification of revisions.

5 AMENDMENT HISTORY

Revision	Amendment description	Author	Approver	Date
-	First issue	A Chapman	C Devine	February 2024
A	Minor non-technical amendments	A Chapman	C Devine	September 2024

6 CONDITIONS OF USE

This Agrément may only be reproduced and distributed in its entirety.

Where a National Annex exists in respect of a BS EN (or other) standard, its use is deemed mandatory wherever the original standard is referenced.

Kiwa Ltd. has used due skill, care and attention in the preparation of this BDA Agrément®.

Whilst all due diligence has been used, no liability or warranty is extended by Kiwa Ltd.

The Agrément holder is responsible for advising Kiwa Ltd. immediately if there is a variation to the System specification or constituent elements/components after initial publication of this BDA Agrément®.

For full terms and conditions, refer to Kiwa Ltd.